

Ultr^on DPS Series

160/200kVA

Uninterruptible Power Supply
User Manual

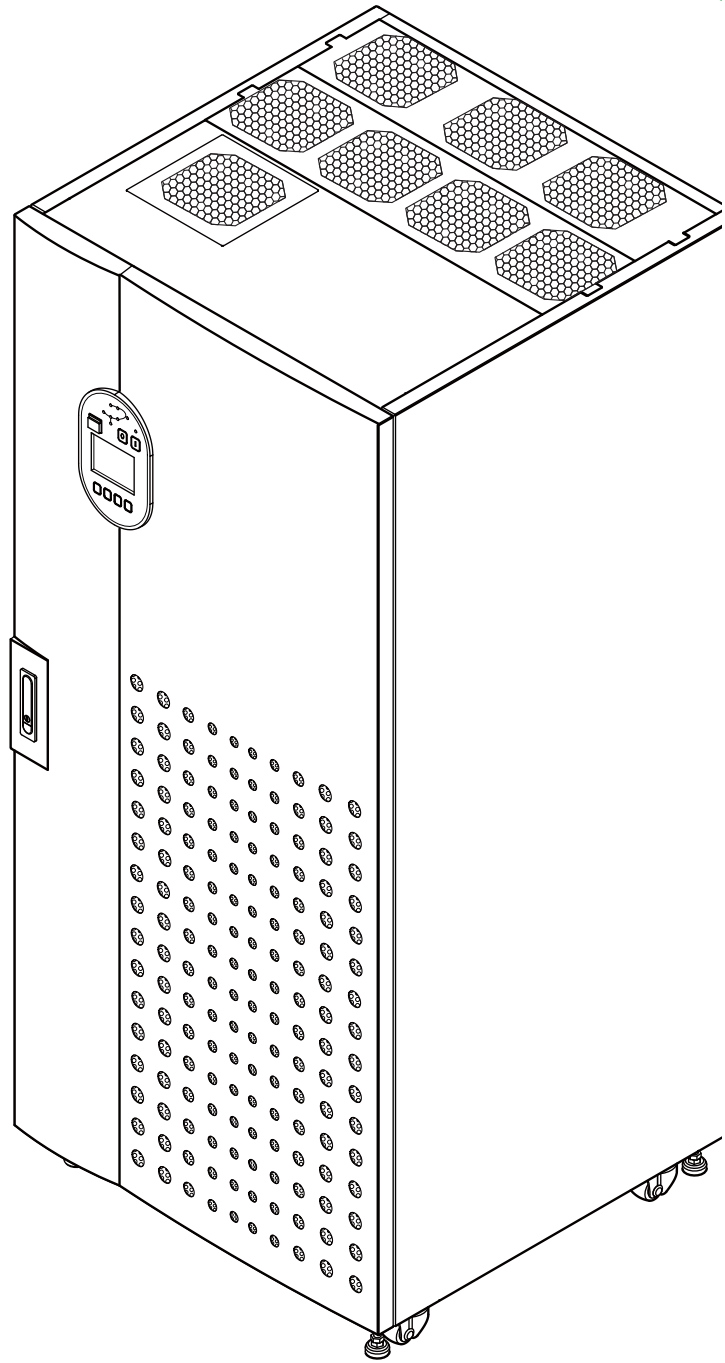

Save This Manual

This manual contains important instructions and warnings that you should follow during the installation, operation, storage and maintenance of this on-line UPS. Failure to heed these instructions and warnings will void the warranty.

Copyright©2010 by Delta Electronics Inc. All rights reserved. The content in this manual belongs to Delta Electronics Inc., hereafter referred to as Delta. No part of this manual can be quoted or reproduced in any form or by any means without the prior written permission of Delta. To continuously improve and develop the product, Delta will make all possible efforts to secure the accuracy and the integrity of this manual. Changes may be made periodically to the information in this manual without obligation to notify any person of such revision or changes. While due caution has been exercised in the production of this manual, possible errors and omissions are unintentional. Delta is not liable for any losses, damages or claims for compensation resulting from wrong interpretation of the text or pictures.

Table of Contents

1.	Important Safety Instructions	1-1
1.1	Installation Warnings	1-2
1.2	Connection Warnings	1-2
1.3	Usage Warnings	1-2
1.4	Storage Warnings	1-3
1.5	Glossary of Symbols	1-3
1.6	Standard Compliance	1-4
2.	Introduction	2-1
2.1	General Overview	2-2
2.2	Package Inspection	2-2
2.3	Features	2-3
2.4	Exterior	2-5
2.4.1	Mechanism Data	2-5
2.4.2	Other Views	2-6
2.5	Control Panel	2-7
2.5.1	LED Indicators	2-7
2.5.2	On, Off, and EPO Buttons	2-8
2.5.3	LCD Display	2-8
2.5.4	Function Keys	2-8
2.6	Internal Mechanisms	2-9
2.6.1	Input & Output Switches	2-9
2.6.2	Fan Fuse & Power Source Fuse	2-10
2.6.3	Wiring Terminal Block	2-11
2.6.4	Communication Interfaces	2-12
2.7	Fans	2-13
3.	Operation Modes	3-1
3.1	Normal Mode (Single)	3-2
3.2	Battery Mode (Single)	3-3
3.3	Bypass Mode (Single)	3-4
3.4	Manual Bypass Mode (Single)	3-5

3.5	ECO Mode	3-6
3.6	Normal Mode (Parallel)	3-7
3.7	Battery Mode (Parallel)	3-8
3.8	Bypass Mode (Parallel)	3-9
3.9	Manual Bypass Mode (Parallel)	3-10
3.10	Hot Standby Redundancy	3-11
3.11	Common Battery	3-13
4.	Communication Interfaces	4-1
4.1	Card Slots	4-2
4.2	RS232 Port	4-2
4.3	Dry Contacts	4-3
4.4	Parallel Ports	4-4
4.5	Dip Switch	4-5
4.6	Output Dry Contacts	4-5
5.	Installation and Wiring	5-1
5.1	Before Installation	5-2
5.2	Installation Environment	5-2
5.3	Transportation	5-3
5.4	Fixing the UPS	5-4
5.5	Wiring	5-6
5.5.1	Pre-wiring Warnings	5-6
5.5.2	Single Input/ Dual Input Modification	5-7
5.5.3	Single Unit Wiring	5-8
5.5.4	Parallel Units Wiring	5-11
5.6	Delta External Battery Cabinet (Optional)	5-13
5.6.1	Usage Warnings	5-13
5.6.2	Exterior, Dimensions, Bottom View with Mounting Holes and Internal Mechanisms	5-15
5.6.3	Delta External Battery Cabinet Wiring	5-17
5.6.4	Delta External Battery Cabinet Alarm	5-18
6.	UPS Operation	6-1
6.1	Single Unit Operation Procedures	6-2
6.1.1	Normal Mode Start-up Procedures (Single)	6-2

6.1.2	Battery Mode Start-up Procedures (Single)	6-5
6.1.3	Bypass Mode Start-up Procedures (Single)	6-6
6.1.4	Manual Bypass Mode Start-up Procedures (Single)	6-7
6.1.5	Normal Mode Turn-off Procedures (Single)	6-11
6.1.6	Battery Mode Turn-off Procedures (Single)	6-12
6.1.7	Bypass Mode Turn-off Procedures (Single)	6-13
6.1.8	Manual Bypass Mode Turn-off Procedure (Single)	6-13
6.2	Parallel Units Operation Procedures	6-14
6.2.1	Normal Mode Start-up Procedures (Parallel)	6-15
6.2.2	Battery Mode Start-up Procedures(Parallel)	6-18
6.2.3	Bypass Mode Start-up Procedures (Parallel)	6-20
6.2.4	Manual Bypass Mode Start-up Procedures (Parallel)	6-21
6.2.5	Normal Mode Turn-off Procedures (Parallel)	6-26
6.2.6	Battery Mode Turn-off Procedures (Parallel)	6-29
6.2.7	Bypass Mode Turn-off Procedures (Parallel)	6-31
6.2.8	Manual Bypass Mode Turn-off Procedure (Parallel)	6-32
7.	LCD Display & Settings	7-1
7.1	LCD Display & Function Keys	7-2
7.2	Main Screen	7-3
7.3	Main Menu	7-7
7.3.1	LCD Display Hierarchy	7-8
7.4	Measure	7-9
7.5	UPS Setup & Control	7-11
7.5.1	Bypass Setup	7-13
7.5.2	Output Setup	7-14
7.5.3	Battery Setup	7-18
7.5.4	Charger Setup	7-23
7.5.5	Parallel Setup	7-25
7.5.6	Control & Test Setup	7-27
7.5.7	Local Setup	7-31
7.6	Maintenance	7-35
7.6.1	Firmware Version	7-36
7.6.2	Statistics	7-36

7.6.3	Event Log	7-36
7.6.4	Advanced Setup	7-37
8.	Optional Accessories	8-1
9.	Maintenance	9-1
10.	Troubleshooting	10-1
Appendix 1: Technical Specifications		A1-1
Appendix 2: Warranty		A2-1

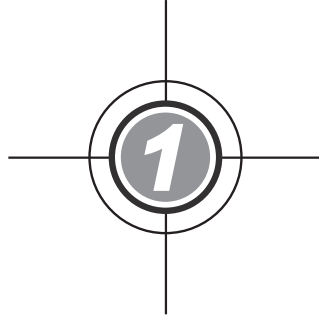

Important Safety Instructions

1.1 Installation Warnings

1.2 Connection Warnings

1.3 Usage Warnings

1.4 Storage Warnings

1.5 Glossary of Symbols

1.6 Standard Compliance

1.1 Installation Warnings

- This is a three-phase four-wire on-line UPS. It can be used for commercial and industrial applications.
- Install the UPS in a well-ventilated indoor area, away from excess moisture, heat, dust, flammable gas or explosives.
- Leave adequate space around all sides of the UPS for proper ventilation and maintenance. Please refer to **5.2 Installation Environment**.
- Only authorized Delta engineers or service personnel can perform installation and maintenance. If you want to install the UPS by yourself, please install it under the supervision of authorized Delta engineers or service personnel
- Follow the IEC 60364-4-42 standard to install the UPS.

1.2 Connection Warnings

- Before applying electrical power to the UPS, make sure the UPS is grounded to avoid a possible risk of current leakage.
- The installation of protective devices is highly recommended when the UPS is connected to power sources and equipment loads.
- The protective devices connecting to the UPS must be installed near the UPS and must be easily accessible for operation.

1.3 Usage Warnings

- The UPS can be used to power computers and associated peripheral devices, such as monitors, modems, cartridge tape drives, external hard drives, etc. If you want to connect inductive or capacitive loads to the UPS, it needs derating. Please contact Delta service personnel for derating information.
- The external slits and openings in the UPS are provided for ventilation. To ensure reliable operation of the UPS and to protect the UPS from overheating, these slits and openings must not be clogged or covered. Do not insert any object into the slits and openings that may hinder ventilation.
- Before usage, you must allow the UPS to adjust to room temperature (20°C~25°C) for at least one hour to avoid moisture condensing inside the UPS.
- Do not put beverages on the UPS, battery cabinet or any other accessory associated with the UPS.
- Do not open or remove the cover of the UPS to avoid high voltage electric shock. Only authorized Delta engineers or service personnel can do so for installation or maintenance. If you want to open or remove the cover, do it only under the supervision of authorized Delta engineers or service personnel.
- The protective devices shall be four-pole devices and shall disconnect all line conductors and neutral conductors when the protective devices are set to OFF position.

- The risk of dangerous high voltage is possible when batteries are still connected to the UPS even though the UPS is disconnected from AC power sources. Do not forget to set a battery disconnect to the OFF position to cut off the battery source.
- Do not dispose of the battery or batteries in a fire. The batteries may explode.
- Do not open or damage the battery or batteries. The released electrolyte is harmful to the skin and eyes and may be toxic.
- A battery can present a risk of electric shock and high short-circuit current. The following precautions should be observed before replacement of batteries:
 1. Remove watches, rings, or other metal objects.
 2. Use tools with insulated handles.
 3. Wear rubber gloves and boots.
 4. Do not lay tools or metal parts on the top of batteries.
 5. Disconnect the charging source prior to connecting or disconnecting the batteries' terminals.
- You must contact qualified Delta service personnel if either of the following events occur:
 1. Liquid is poured or splashed on the UPS.
 2. The UPS does not run normally after carefully following the instructions in this User Manual.

**NOTE**





















If you use the UPS in an area that generates or incurs dust, you should install dust filters in the UPS to ensure product life and function.

1.4 Storage Warnings

- Use the original packing material to pack the UPS to prevent any possible damage from rodents.
- If the UPS needs to be stored prior to installation, it should be placed in a dry indoor area. The allowable storage temperature is below 40°C and relative humidity is below 90%.

1.5 Glossary of Symbols

Item	Symbol	Description
1	R	R-phase
2	S	S-phase
3	T	T-phase
4	N	Neutral
5		Grounding (Protective earthing conductor)

6		Bonded to ground
7		Positive battery terminal
8		Negative battery terminal
9		On button
10		Off button
11		Main AC source LED
12		Bypass AC source LED
13		Inverter Start-up LED
14		Inverter Power Supply LED
15		Bypass Power Supply LED
16		Battery Power Supply LED
17		Output Switch LED
18		Fault LED
19		Goes back to previous screen or cancels current selection.
20		Moves up
21		Moves down
22		Moves left
23		Moves right
24		Increases number
25		Decreases number
26		Confirms selection

1.6 Standard Compliance

- EN 62040-1-2
- EN 62040-2 Class A
- IEC 61000-4-2 Level 4
- IEC 61000-4-3 Level 3
- IEC 61000-4-4 Level 4
- IEC 61000-4-5 Level 4
- IEC 61000-4-6

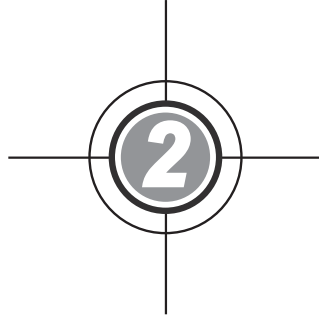

Introduction

2.1 General Overview

2.2 Package Inspection

2.3 Features

2.4 Exterior

2.5 Control Panel

2.6 Internal Mechanisms

2.7 Fans

2.1 General Overview

The DPS series UPS, a three-phase four-wire on-line uninterruptible power supply, is a dedicated design for large scale power systems such as data centers, communication systems, network rooms, emergency systems and factory facilities. The unit adopts advanced IGBT technology to provide perfect, clean, pure sine waves and high-quality output power to the equipment loads connected. It features high efficiency, low heat consumption, low noise, and high reliability.

The unit's dual-input power supply and hot standby redundancy functions provide reliable power protection to your sensitive equipment when unexpected power problems occur. Using the RS232 port, you can connect the UPS to a PC to monitor relevant issues. With the installation of Delta InsightPower Manager software (free on website, <http://59.125.232.140>), you can monitor several UPSs placed in a computer room or a factory to facilitate centralized control. Besides, you can parallel at maximum eight UPS units without using any external parallel card to increase the system capacity and redundancy and enhance the unit's availability and reliability.

2.2 Package Inspection

- **External**

During UPS transportation, some unpredictable situations might occur. It is recommended that you inspect the UPS exterior packaging. If you notice any damage, please immediately contact the dealer from whom you purchased the unit.

- **Internal**

1. Check the rating label on the inside of the front door and make sure the device No. and capacity match what you ordered.
2. Examine if any parts are loose or damaged.
3. The UPS package contains the following items. Please check if any items are missing.

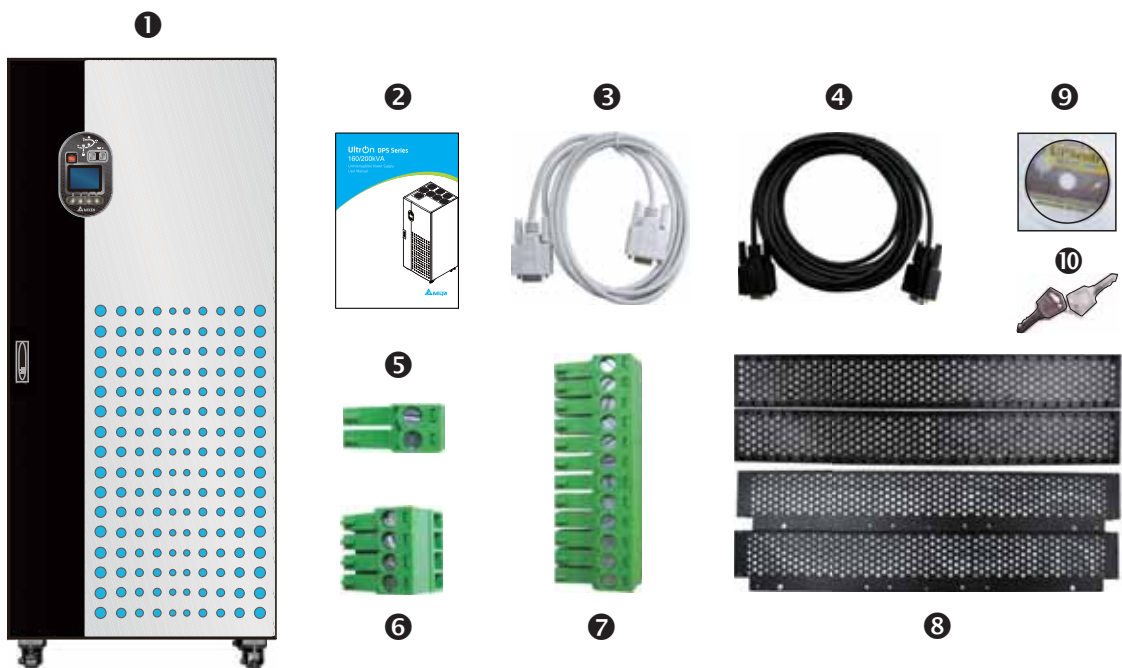

No.	Item	Quantity
①	UPS	1 pc
②	User Manual	1 pc
③	RS232 Cable	1 pc (1.8-meter long)
④	Parallel Cable	1 pc (5-meter long)
⑤	REPO Dry Contact Terminal	1 set (2-Pin)
⑥	Input Dry Contact Terminal	1 set (4-Pin)
⑦	Output Dry Contact Terminal	1 set (12-Pin)
⑧	Rodent-proof Shield	1 set (4 PCS)
⑨	Software CD-UPSentry Smart 2000	1 pc
⑩	Key	1 pc (two copies placed inside the UPS cabinet)

4. If there is any damage or anything missing, please immediately contact the dealer from whom you purchased the unit.
5. If the UPS needs to be returned, carefully repack the UPS and all of the accessories using the original packing material that came with the unit.

2.3 Features

- True on-line double-conversion design UPS adopts DSP chip and IGBT technology to protect your sensitive electronic equipment from power interruption.
- Input power factor > 0.99 and input THDi < 3% save on installation cost and diminish power contamination.
- Efficiency > 95% saves on operation cost.
- Wide AC input voltage range (140Vac~276Vac) reduces frequent transfer from normal mode to battery mode to save battery consumption and prolong battery life.
- Batteries power on the UPS to provide stable AC power when there is no AC line available.
- Automatic input frequency detection enables operation at 50Hz or 60Hz.
- Optional ECO Mode: when input voltage and frequency are within the range of rating voltage $\pm 10\%$ and rating frequency $\pm 5\text{Hz}$, the UPS will transfer to bypass mode; otherwise, the UPS will transfer to normal mode to reach higher efficiency.
- Automatically detects whether bypass voltage is out of rating voltage. If yes, the UPS will stop supplying power to the equipment loads to protect your electronic equipment.
- Dual-input design features an independent rectifier and a bypass switch.
- Built-in manual bypass switch.
- Automatic restart:
 1. The UPS will restart in normal mode automatically right after the AC line resumes following a low battery shutdown.

2. The UPS returns automatically to normal mode from bypass mode after an overload condition or a short circuit condition is cleared.
- Surge protection and EMI filter functions.
 - Both auxiliary power and control circuit adopt redundancy design, which doubly enhances UPS reliability.
 - Connects several external battery cabinets (at maximum four) to extend backup time.
 - Sets up battery test and battery replacement alarms.
 - Smart battery charger design allows auto-charging or manual-charging to reduce charging time.
 - Local and remote emergency power off functions.
 - Attaches optional accessories like SNMP, Relay I/O, and ModBus cards for network communication, dry contact, and ModBus communication.
 - Built-in RS232 port allows monitoring and management of the UPS via the UPSentry Smart 2000 software.
 - State-of-the-art microprocessor technology performs self-detection and displays the UPS status on LCD.
 - Built-in SRAM records at maximum 500 event logs.
 - Fans automatically adjust fan speed to prolong fan life and reduce noise when the equipment loads decrease.
 - AC start-up function even when the UPS is not connected to the batteries.

2.4 Exterior

On the front of the UPS, there is a control panel and a lockable door switch. On the top, there are twelve fans to ventilate the UPS to prevent overheating. At the bottom, four casters are designed to move the UPS for short distances, and four levelers fix the UPS to the floor.

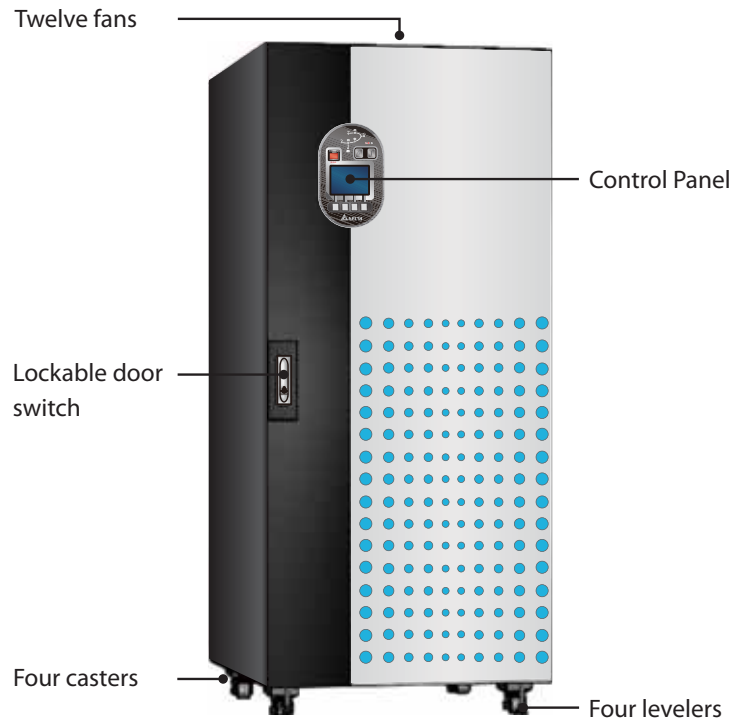

(Figure2-a: UPS Exterior)

2.4.1 Mechanism Data

- 160kVA/ 200kVA

DPS Series UPS Dimensions Table			
Rating	Width (mm)	Depth (mm)	Height (mm)
160kVA/ 200kVA	850	865	1950

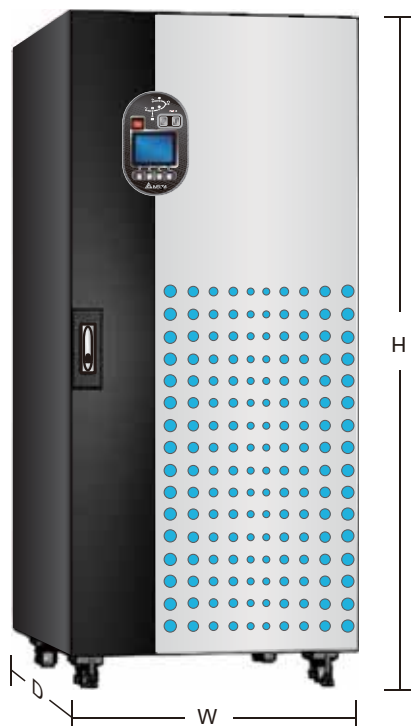

(Figure2-b: Dimensions)

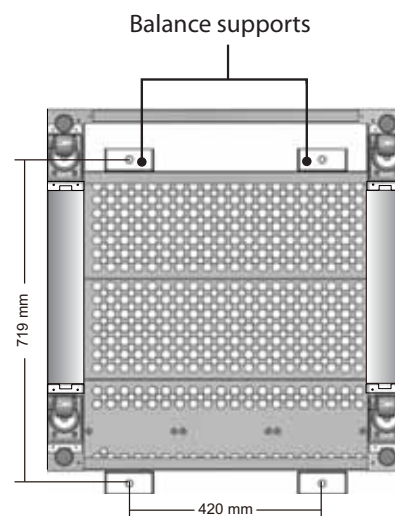

(Figure2-c: Bottom View & Mounting Holes diagram)

2.4.2 Other Views

- **Front view:** control panel, door handle, casters, and levelers. **(Figure 2-d)**
- **Open door:** open front door. **(Figure 2-d)**
- **Front view with door open:** internal mechanisms. **(Figure 2-e)**

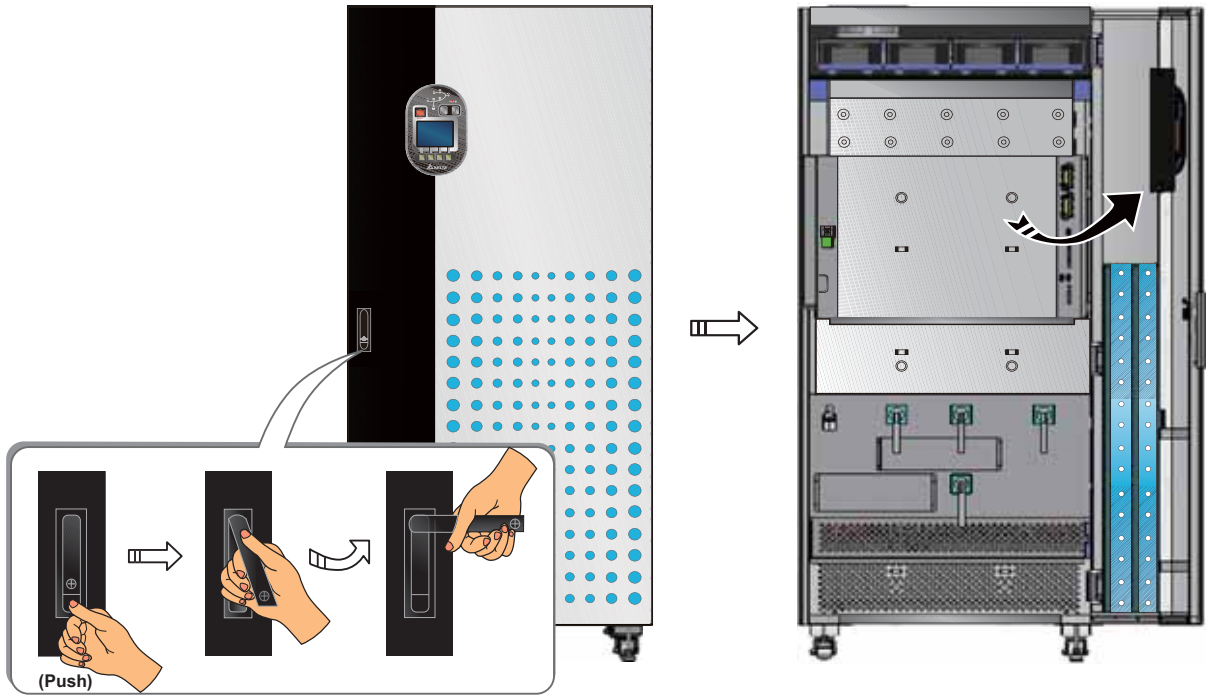

(Figure2-d: Front View & Door Handle)

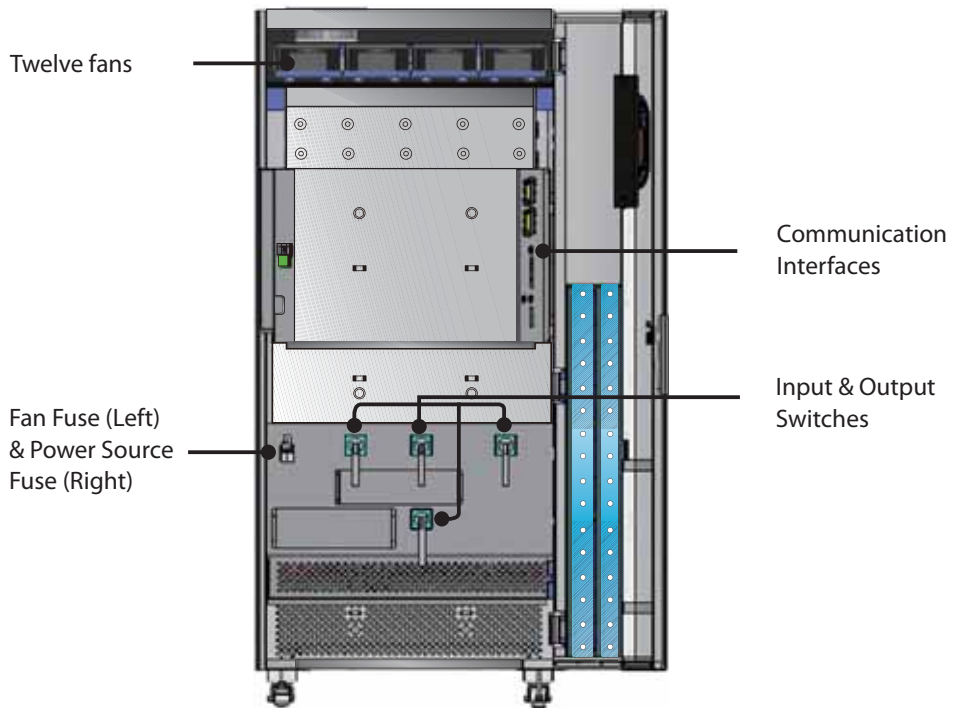

(Figure2-e: Internal Mechanisms)

2.5 Control Panel

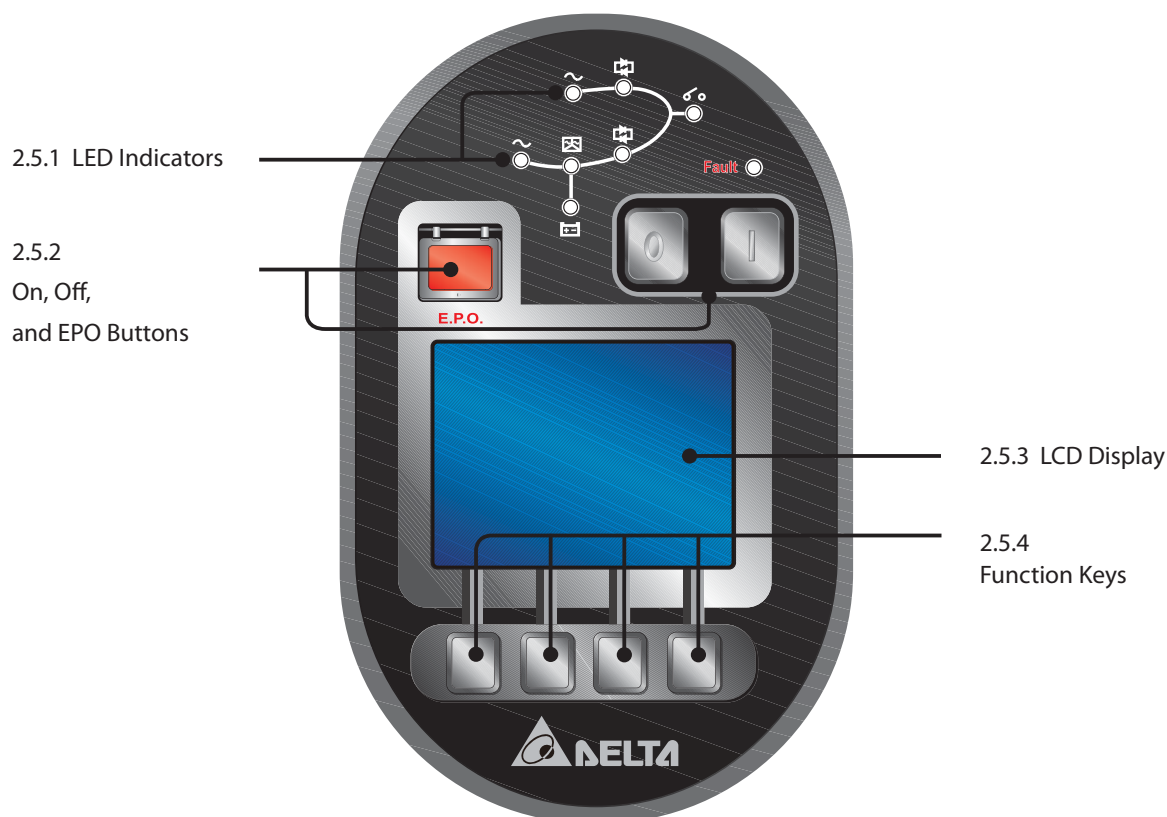



(Figure 2-f: UPS Control Panel)

2.5.1 LED Indicators

LED Symbol	Name	LED On Meaning	LED
~	Main AC Source LED	When main AC Source is normal.	Green
~	Bypass AC Source LED	When bypass AC Source is normal.	Green
⚡	Inverter Start-up LED	When the UPS's inverter starts up.	Green
⚡	Inverter Power Supply LED	When the inverter supplies power to the equipment loads.	Green
⚡	Bypass Power Supply LED	When the bypass supplies power to the equipment loads.	Yellow
⚡	Battery Power Supply LED	When the batteries supply power to the equipment loads.	Yellow
⚡	Output Switch LED	When you turn on the UPS Output Switch.	Green
Fault Ⓞ	Fault LED	When problems occur.	Red

2.5.2 On, Off, and EPO Buttons

Button	Name	Function
	On Button	Press this button for 3 seconds and release it after you hear one beep to turn on the UPS (the inverter will be on). If you don't release the button after you hear the beep, the UPS will still start up within 7 seconds. After 7 seconds, the UPS won't start up.
	Off Button	<p>Press this button for 3 seconds, release it after you hear one beep and the system will show the message below.</p> <div style="text-align: center; border: 1px solid black; padding: 5px; background-color: #003366; color: white;"> SHUTDOWN UPS? YES NO </div> <p>Select YES to turn off the UPS (the inverter will off). If you select YES and the system detects there is a risk of power interruption during conversion from inverter to bypass, the UPS will show the following message.</p> <div style="text-align: center; border: 1px solid black; padding: 5px; background-color: #003366; color: white;"> PLL FAIL! SHUTDOWN UPS? YES NO </div> <p>To confirm turning off the UPS, select YES again. Please see 7. LCD Display and Settings for control panel operation.</p>
	EPO Button	When an emergency occurs, turn off this button to shut down the UPS rectifier, inverter and output.

2.5.3 LCD Display









The UPS supports multi-language LCD display. The language default setting is English. If you wish to change the language default setting, please refer to **7.5 UPS Setup & Control** and **7.5.7 Local Setup**.



The language default setting may be different according to countries.

2.5.4 Function Keys

There are no symbols on the function keys. The functions of keys depend on symbols appearing on the LCD. Please see the table below.

No.	Symbol	Function
1		Goes back to previous screen or cancels current selection.
2		Moves up
3		Moves down
4		Moves left
5		Moves right
6		Increases number
7		Decreases number
8		Confirms selection

2.6 Internal Mechanisms

2.6.1 Input & Output Switches

The input and output switches include Main Input Switch (Q1), Bypass Switch (Q2), Manual Bypass Switch (Q3) and UPS Output Switch (Q4). Each switch has a switch and fuses.

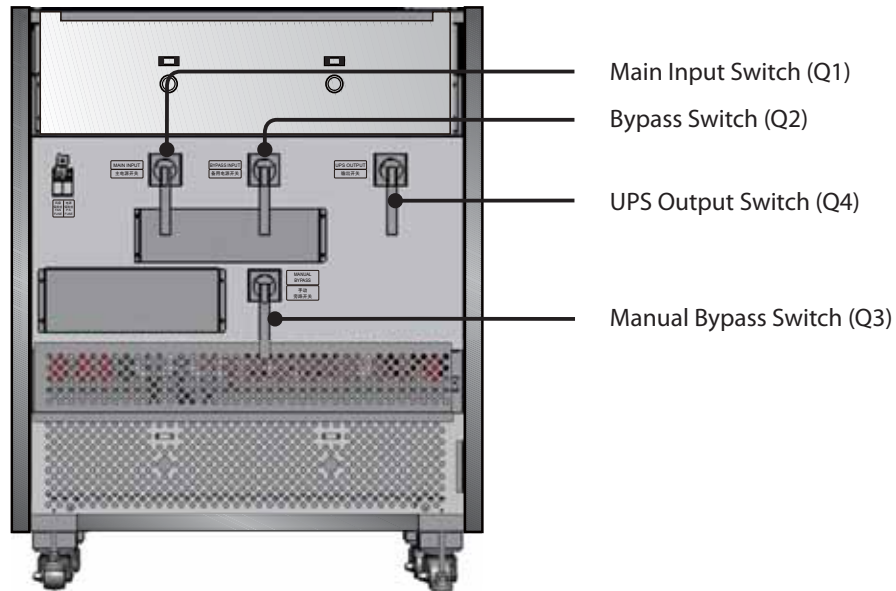

(Figure 2-g: Input & Output Switches)

Please see the following figure to turn on/ off a switch.

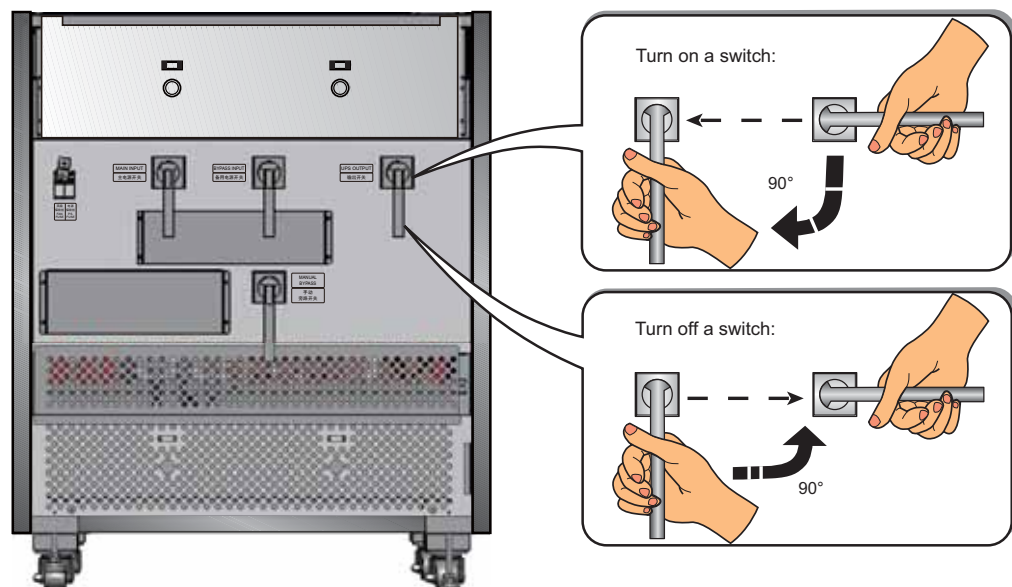

(Figure 2-h: Turn on/ off a Switch)

2.6.2 Fan Fuse & Power Source Fuse

When fan abnormalities cause an over-current condition, the fan fuse will automatically fuse to prevent fans from overheating. The power source fuse ensures that the UPS runs normally. Before turning on the UPS, please make sure you have closed the fuse holders of the fan fuse and the power source fuse. Please see the figures below to open/ close a fuse holder.

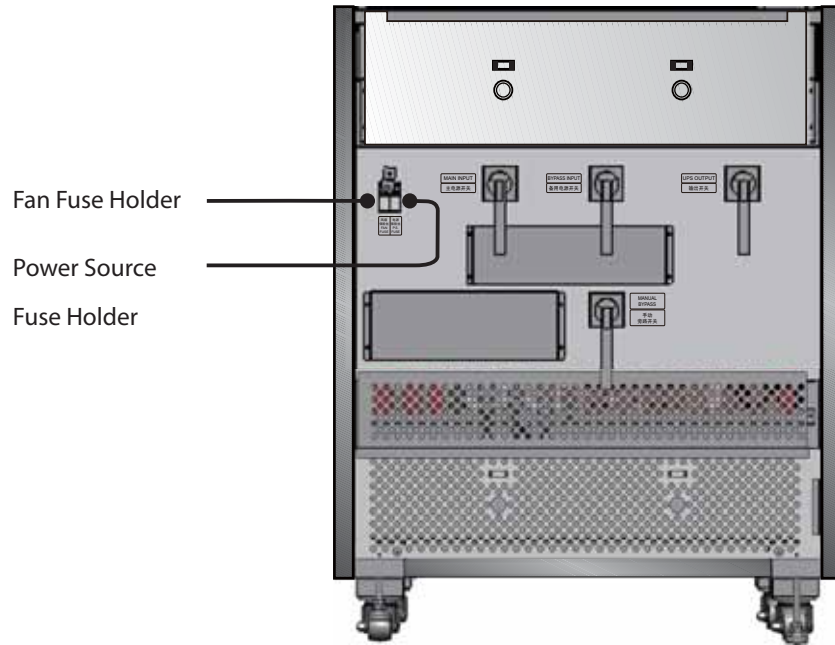

(Figure 2-i: Fan Fuse & Power Source Fuse Holders)

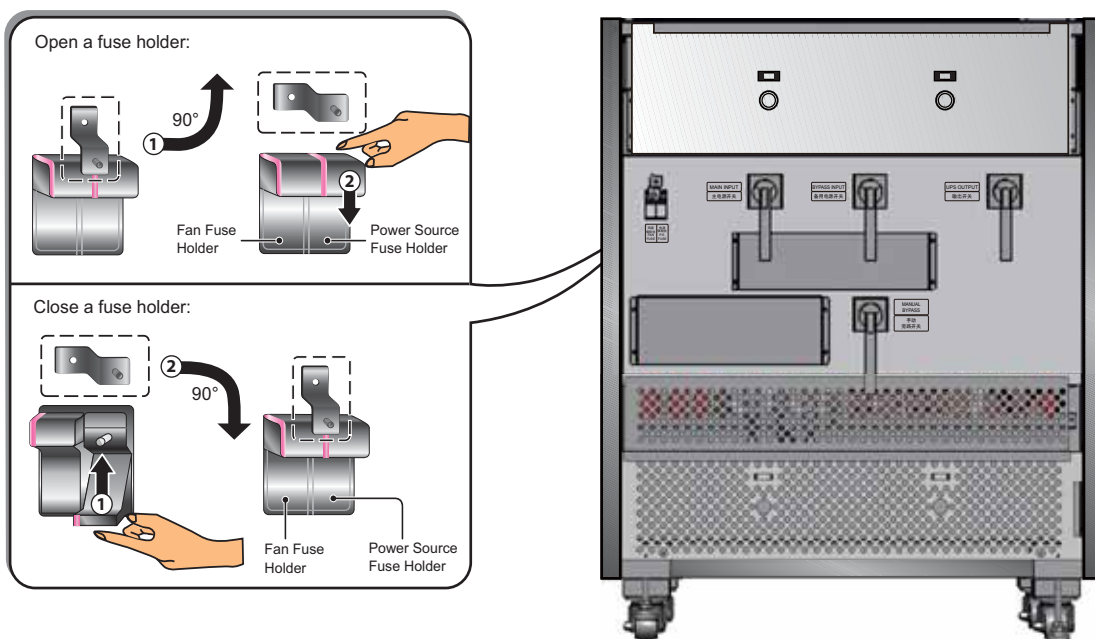

Please see the following figure to open/ close a fuse holder.



(Figure 2-j: Open/ Close a Fuse Holder)

2.6.3 Wiring Terminal Block

After removing the panel (please see **Figure 2-k** for panel location), you can see the wiring terminal block shown in **Figure 2-l**. The wiring terminal block includes the following.

Item	Function	Description
1. Battery Input Block	Connects an external battery cabinet	Includes positive (+), negative (-) and neutral (N) terminals.
2. Main Input Block	Connects main AC source	Includes three phases (R, S, T) and neutral (N) terminals.
3. 	For UPS grounding (safety)	Includes one grounding terminal.
4. Bypass Input Block	Connects bypass AC source	Includes three phases (R, S, T) terminals.
5. UPS Output Block	Connects the equipment loads	Includes three phases (R, S, T), one neutral (N) and one grounding () terminals.



NOTE

Please connect the bypass AC source's neutral to the neutral (N) terminal of the Main Input Block.



(Figure 2-k: Panel Location)

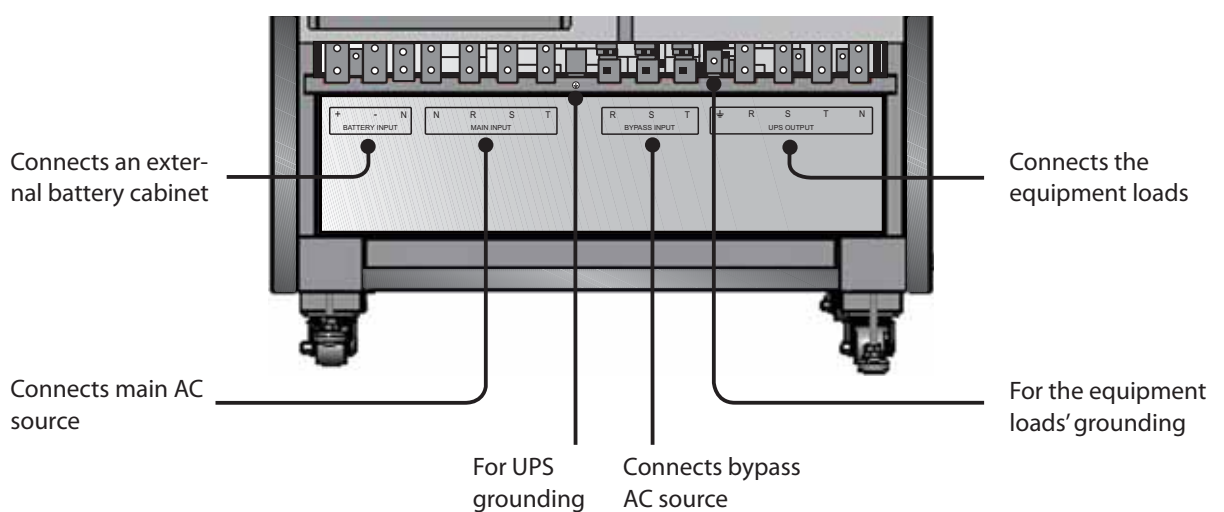

(Figure 2-l: Wiring Terminal Block)

NOTE 

1. Only authorized Delta engineers or service personnel can remove the panel of the wiring terminal block and perform wiring. If you want to remove the panel and perform wiring yourself, you must do it under the supervision of authorized Delta engineers or service personnel.
2. Phase symbols are different between countries. Please refer to the table below.

USA/ Asia	Europe	India
R	U	R
S	V	Y
T	W	B

2.6.4 Communication Interfaces

Communication interfaces include card slots, an RS232 port, dry contacts, parallel ports, a dip switch, and output dry contacts as shown in the figure below. Please see **4. Communication Interfaces** for details.

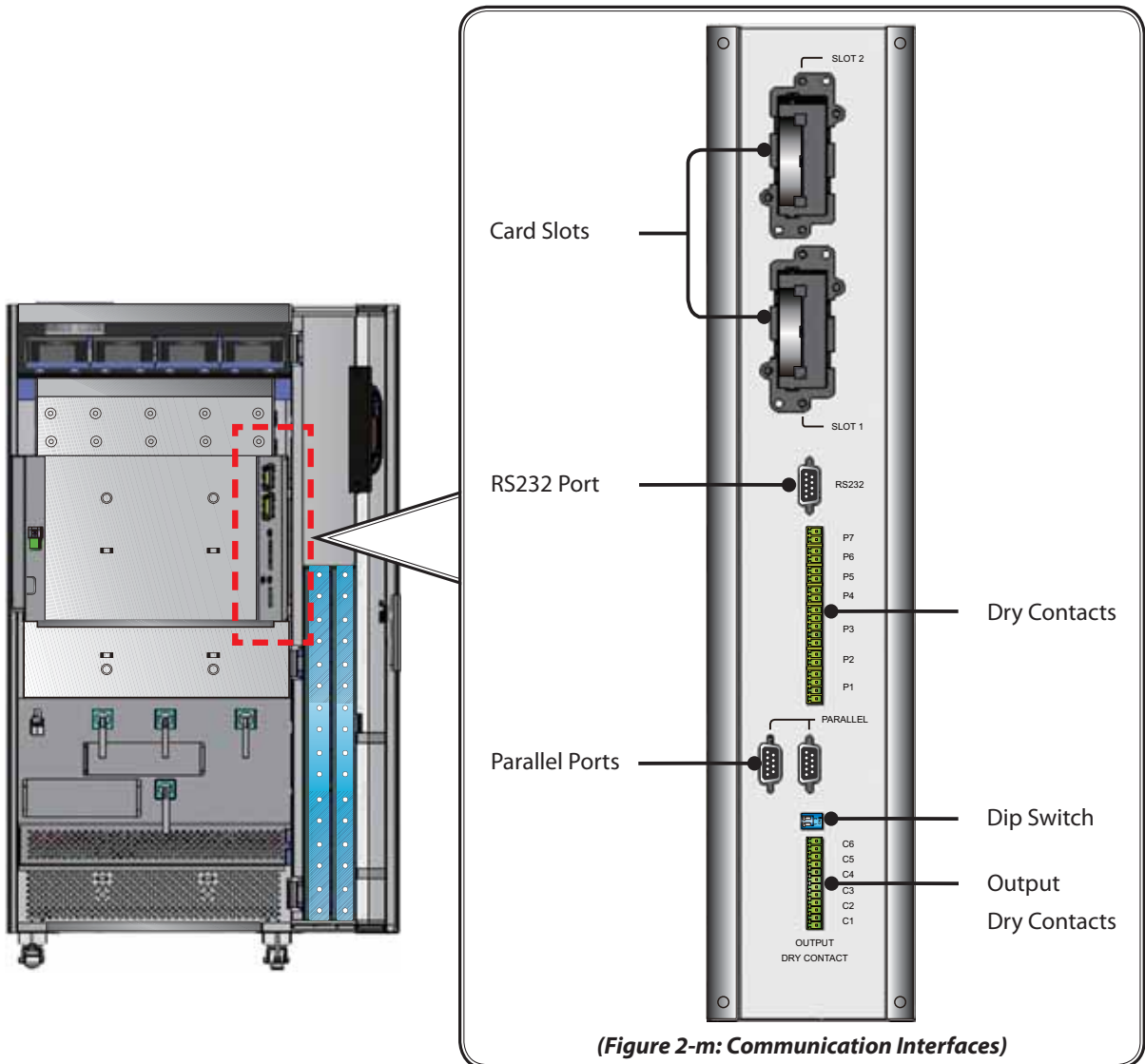

(Figure 2-m: Communication Interfaces)

2.7 Fans

There are 12 fans on the top of the UPS to assist ventilation. Please see **Figure 2-n** for fan location. The system senses the equipment loads connected and decides the fan speed. Fans will run at the highest speed only when an over-current condition occurs (battery over temperature is excluded).

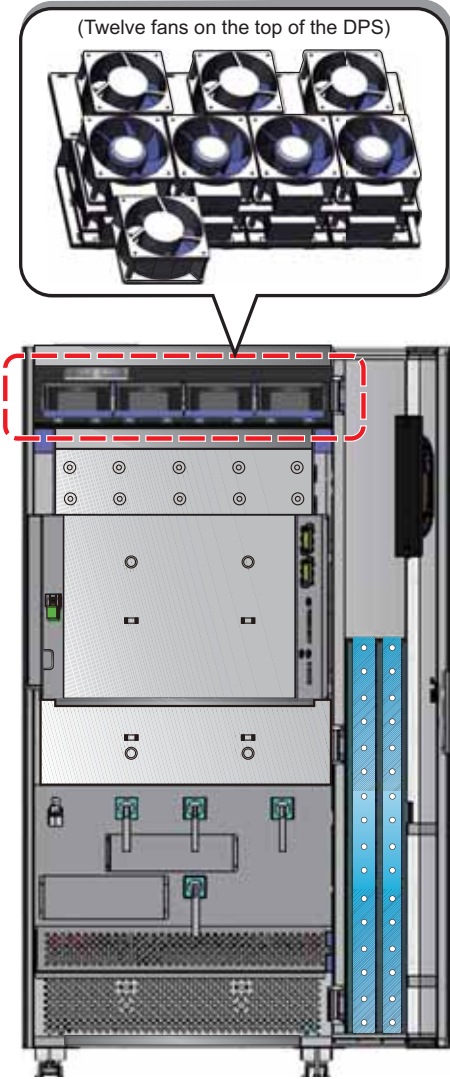

(Figure 2-n: UPS Fans Location)

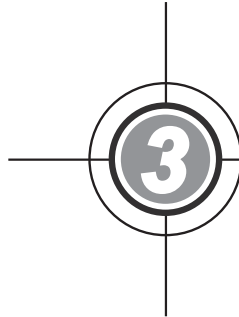

Operation Modes

3.1 Normal Mode (Single)

3.2 Battery Mode (Single)

3.3 Bypass Mode (Single)

3.4 Manual Bypass Mode (Single)

3.5 ECO Mode

3.6 Normal Mode (Parallel)

3.7 Battery Mode (Parallel)

3.8 Bypass Mode (Parallel)

3.9 Manual Bypass Mode (Parallel)

3.10 Hot Standby Redundancy

3.11 Common Battery

The UPS system supplies power to the connected equipment loads with four basic operation modes, which are normal mode, battery mode, bypass mode and manual bypass mode. The unit automatically switches between these modes as required to make sure that the equipment loads are protected from power interruption. Besides these four operation modes, the UPS is also designed for hot standby redundancy, common battery, and ECO mode functions. Please see the following sections for single unit and parallel units' operation modes, hot standby redundancy, common battery and ECO mode configurations.

NOTE 

Q1, Q2, Q3 and Q4 Switches shown in the following diagrams represent Main Input Switch, Bypass Switch, Manual Bypass Switch, and UPS Output Switch respectively.

3.1 Normal Mode (Single)

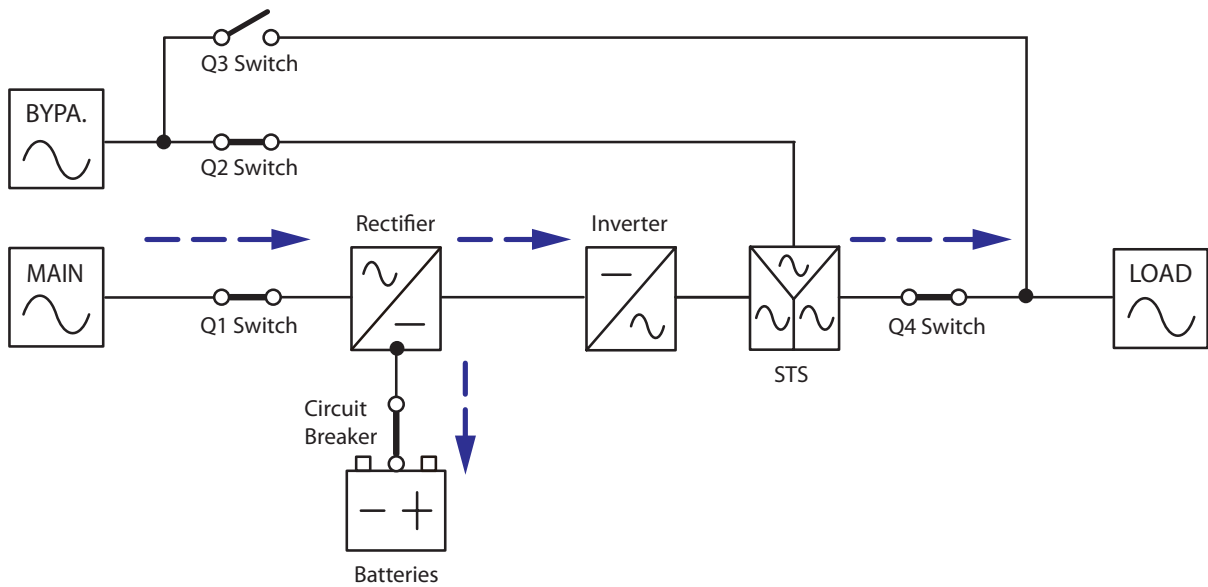

(Figure 3-a: Path of Electrical Power through the UPS in Normal Mode)

In normal mode, the main AC source supplies AC power via the Main Input Switch (Q1) to the rectifier, and the rectifier converts the AC power to DC power and supplies the DC power to the inverter. In the meantime, the rectifier provides charging power to the batteries. After receiving the DC power, the inverter converts it into clean and stable AC power before the static switch. After that, the inverter supplies the AC power via the static switch and the UPS Output Switch (Q4) to the connected equipment loads. During normal mode, LEDs illuminate as follows.

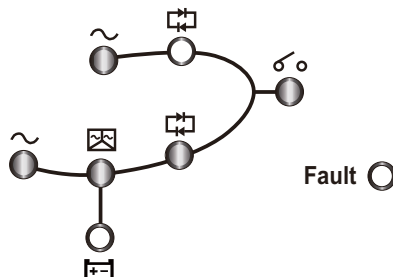

3.2 Battery Mode (Single)

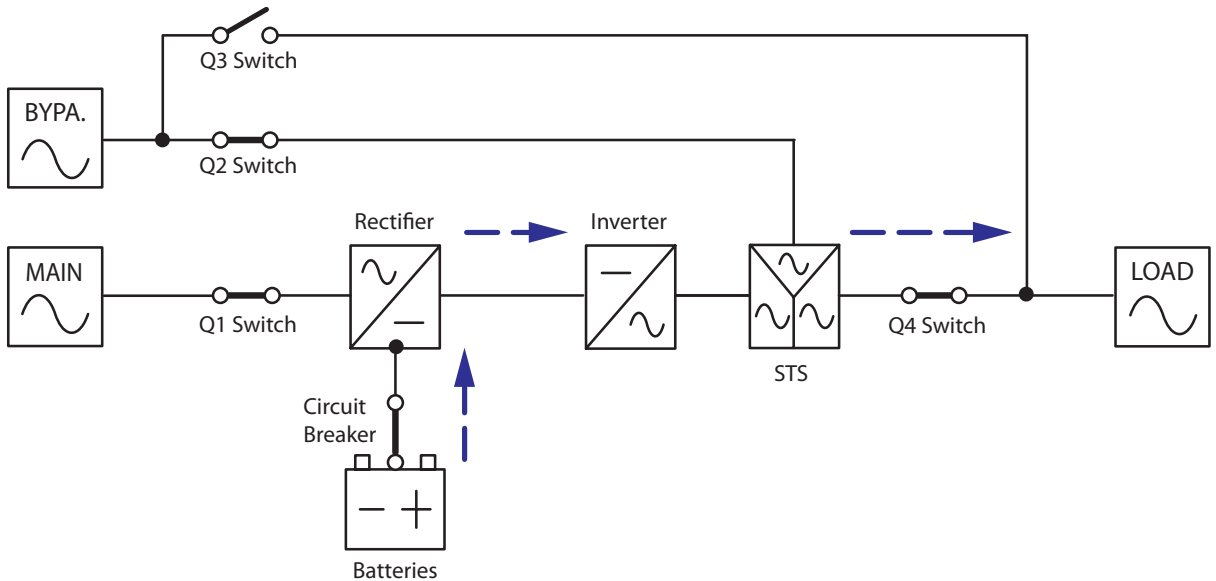

(Figure 3-b: Path of Electrical Power through the UPS in Battery Mode)

The UPS transfers to battery mode automatically if the main AC source cannot supply power, for example, when unstable voltage or a power outage occurs. In battery mode, the batteries provide DC power and the inverter converts it into AC power and supplies it to the connected equipment loads via the static switch and the UPS Output Switch (Q4). During the conversion process, output voltage remains the same, and during battery mode, LEDs illuminate as follows.

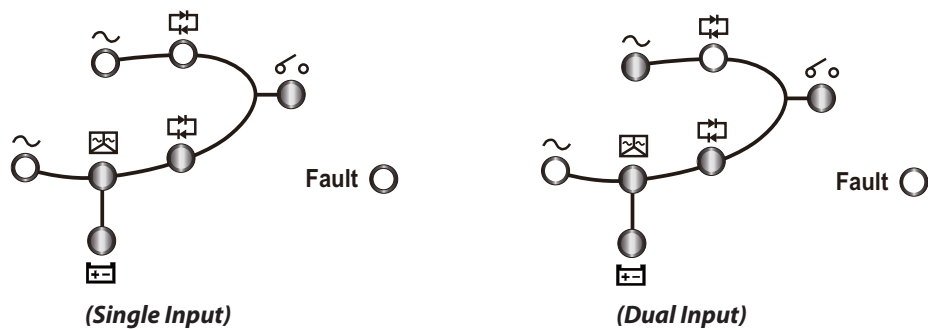

NOTE

The default setting is single input. Please refer to **5.5.2 Single Input/ Dual Input Modification**.

3.3 Bypass Mode (Single)

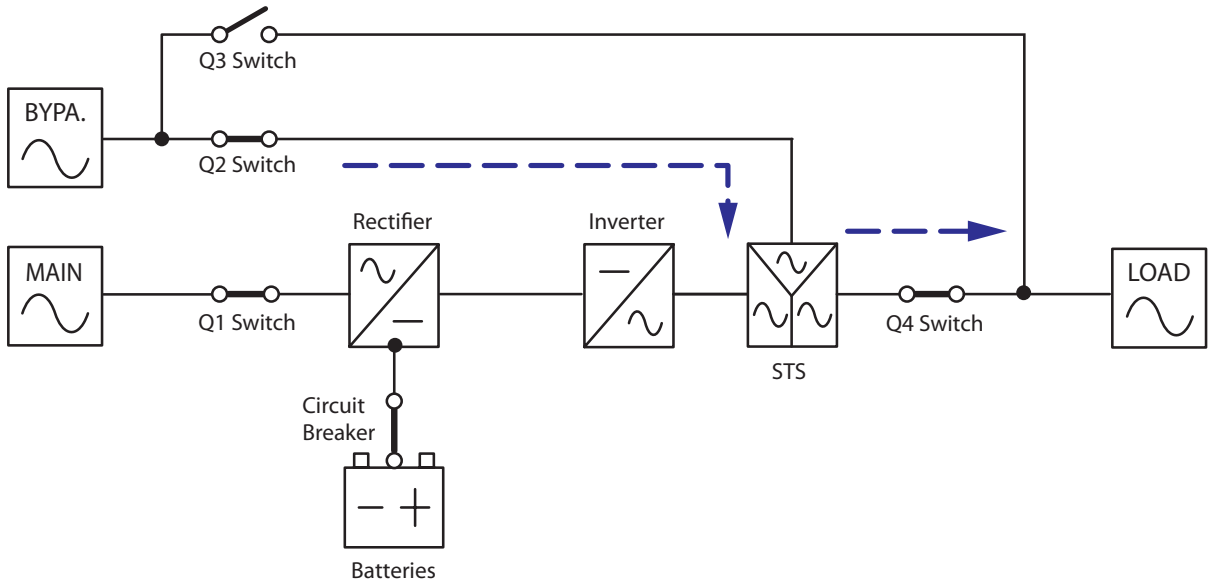

(Figure 3-c: Path of Electrical Power through the UPS in Bypass Mode)

When the inverter encounters abnormal situations such as over temperature, overload, short circuit, abnormal output voltage and battery depletion, it will automatically shut itself down to protect the UPS system. Meanwhile, if the UPS detects the bypass AC source is normal, it will automatically switch to bypass mode to protect the connected equipment loads from power interruption. After abnormalities are eliminated, the UPS will switch back to normal mode from bypass mode. During bypass mode, LEDs illuminate as follows.

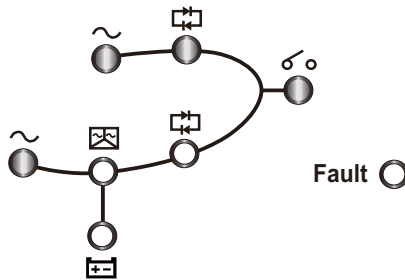

3.4 Manual Bypass Mode (Single)

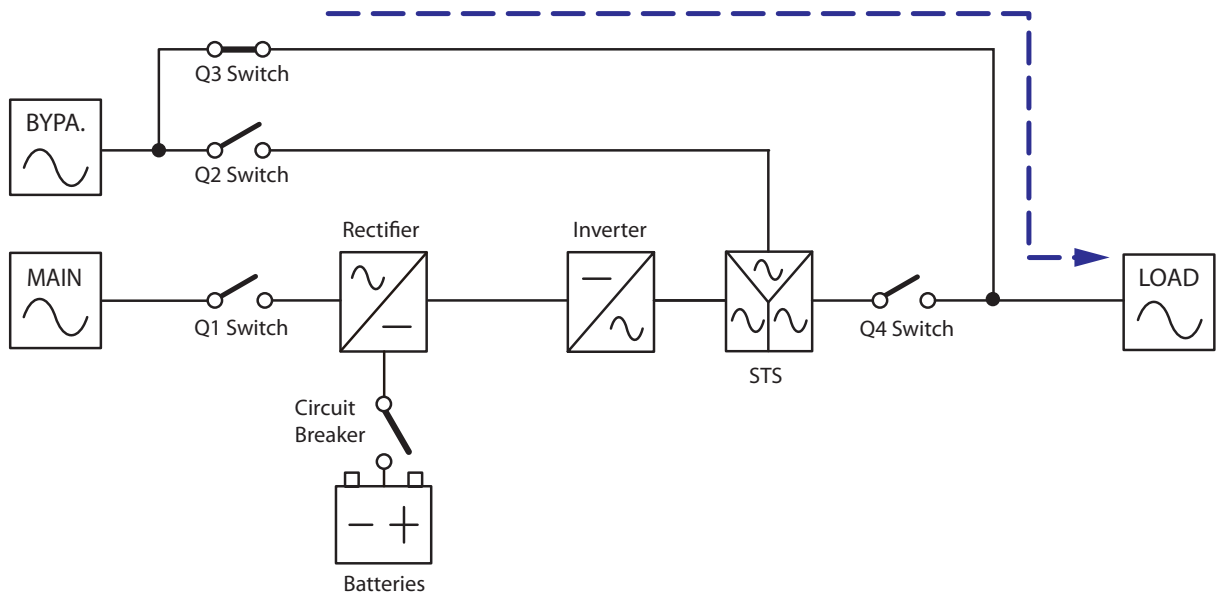

(Figure 3-d: Path of Electrical Power through the UPS in Manual Bypass Mode)

When the UPS needs maintenance, you can manually switch the UPS to manual bypass mode after you have confirmed the bypass AC source is normal. In manual bypass mode, all power inside the UPS is completely cut off and maintenance personnel can perform maintenance safely. During manual bypass mode, no LED illuminates.

NOTE

After the power inside the UPS has been completely cut off, there is no high voltage inside the UPS except the wiring terminals and the Manual Bypass Switch (Q3). Do not touch the wiring terminals or the Manual Bypass Switch (Q3) to avoid electrical shock.

3.5 ECO Mode

You can only use ECO mode for a single unit but not for parallel units. Please refer to **7.2 Main Screen** and **7.5.2 Output Setup**.

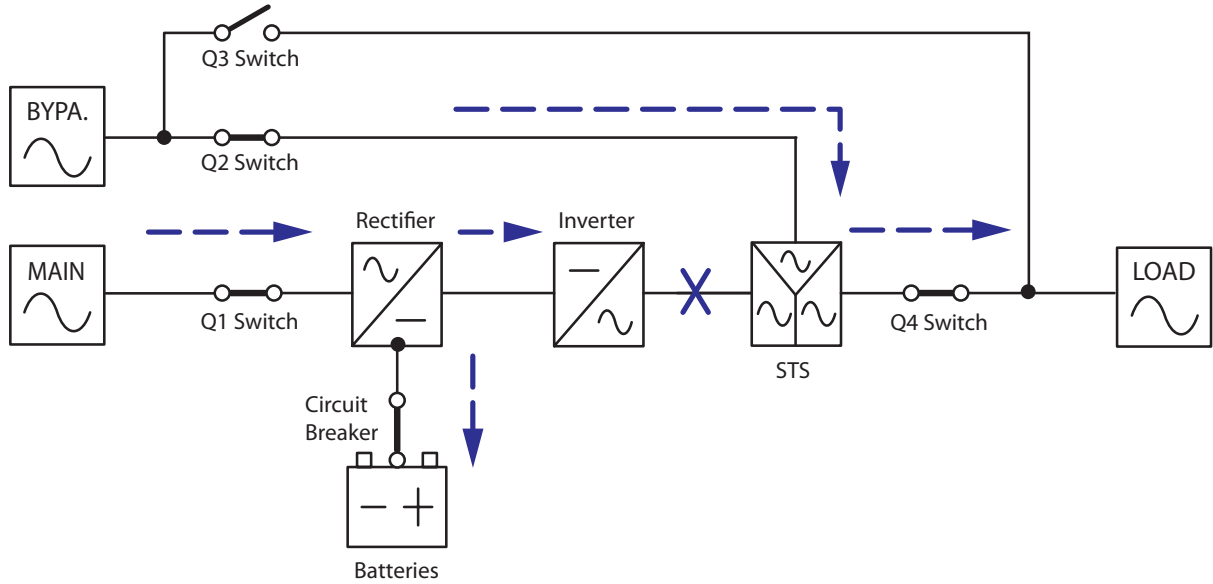

(Figure 3-e: Path of Electrical Power through the Single UPS in ECO Mode)

In ECO mode, when bypass AC source's input voltage and frequency are within the range of rating voltage $\pm 10\%$ and rating frequency $\pm 5\text{Hz}$, the UPS works in bypass mode and LEDs illuminate as follows.

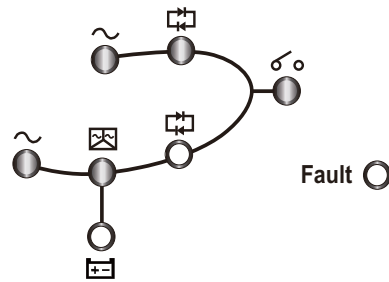

Otherwise, the UPS will convert to normal mode for higher efficiency. Under these circumstances, LEDs illuminate as follows.

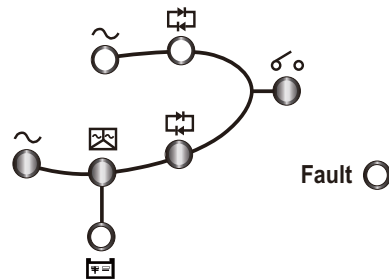

3.6 Normal Mode (Parallel)

The UPS can be paralleled (at maximum eight) to increase capability and redundancy. UPSs with the same capacity, voltage and frequency can be paralleled.

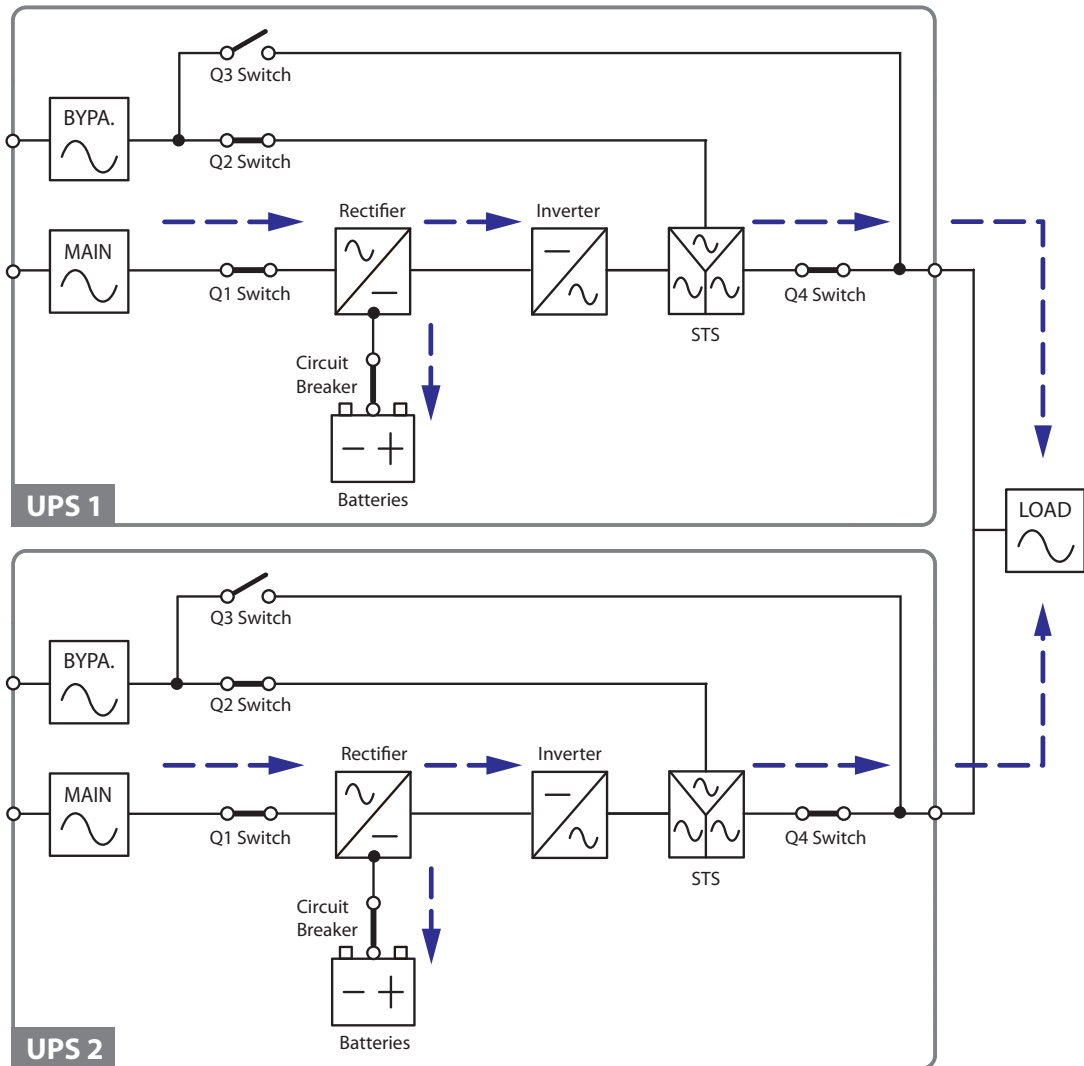

(Figure 3-f: Path of Electrical Power through the Parallel UPSs in Normal Mode)

In normal mode (parallel), the total load will be equally shared by parallel UPSs. If one of the parallel units fails and its load is less than the total capacity of the remaining parallel units, the failing UPS output will be switched off and its load will be equally shared by the other units. If the failing UPS load is larger than the total capacity of the remaining parallel units, all UPSs' inverters will turn off and the total load will be supplied by bypass power. During normal mode, all parallel UPSs' LEDs illuminate as follows.

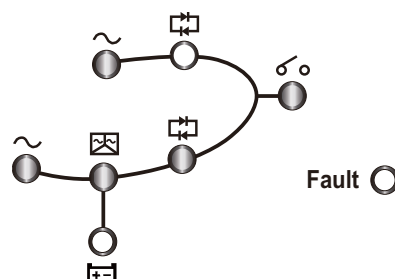

3.7 Battery Mode (Parallel)

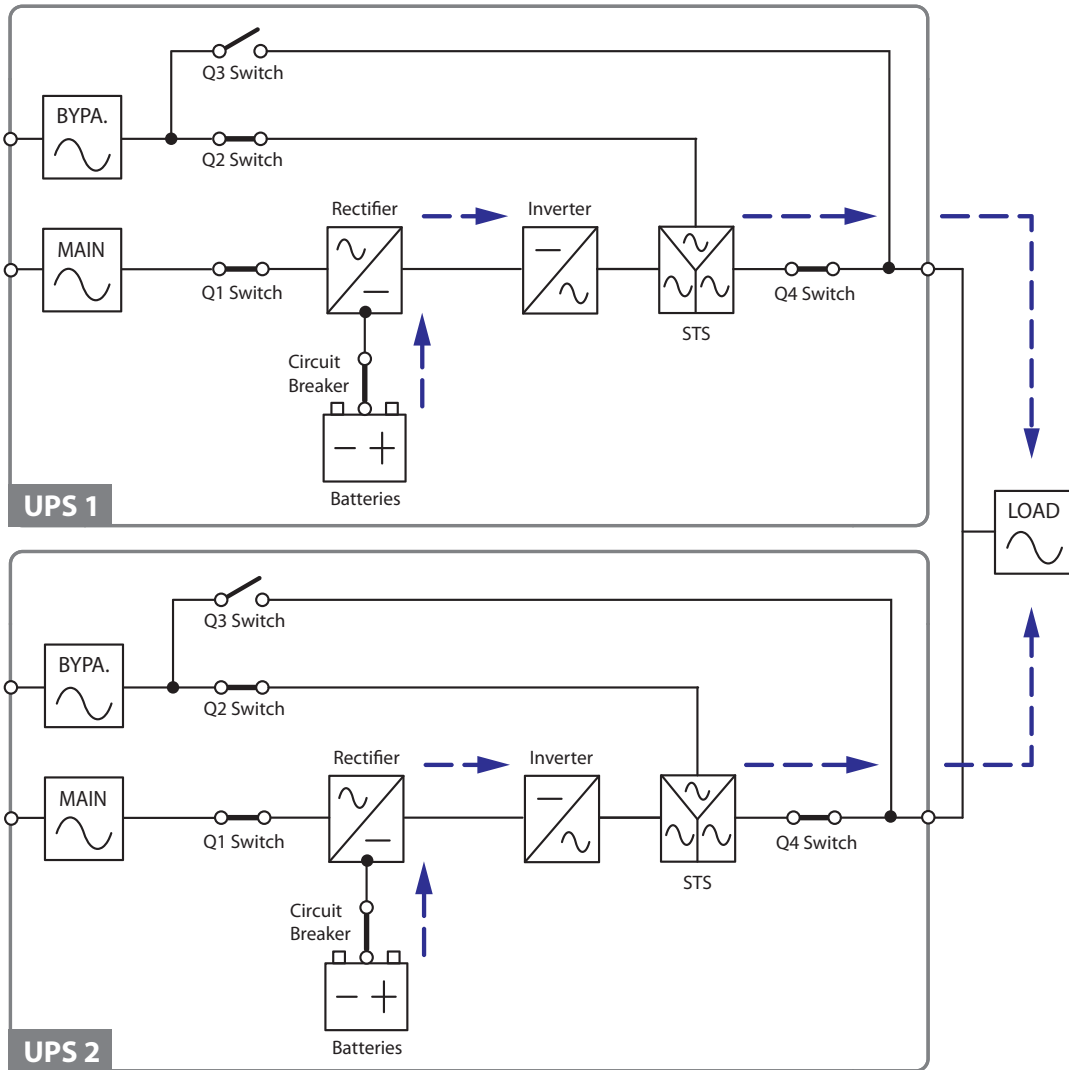

(Figure 3-g: Path of Electrical Power through the Parallel UPSs in Battery Mode)

If the main AC source cannot supply power, for example, when unstable voltage or a power outage occurs, all parallel UPSs will automatically transfer from normal mode to battery mode. During the conversion process, output voltage remains the same, and during battery mode, all parallel UPSs' LEDs illuminate as follows.

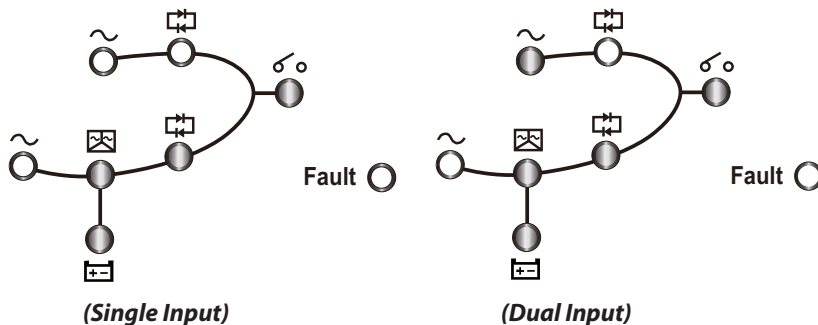

NOTE The default setting is single input. Please refer to **5.5.2 Single Input/ Dual Input Modification.**

3.8 Bypass Mode (Parallel)

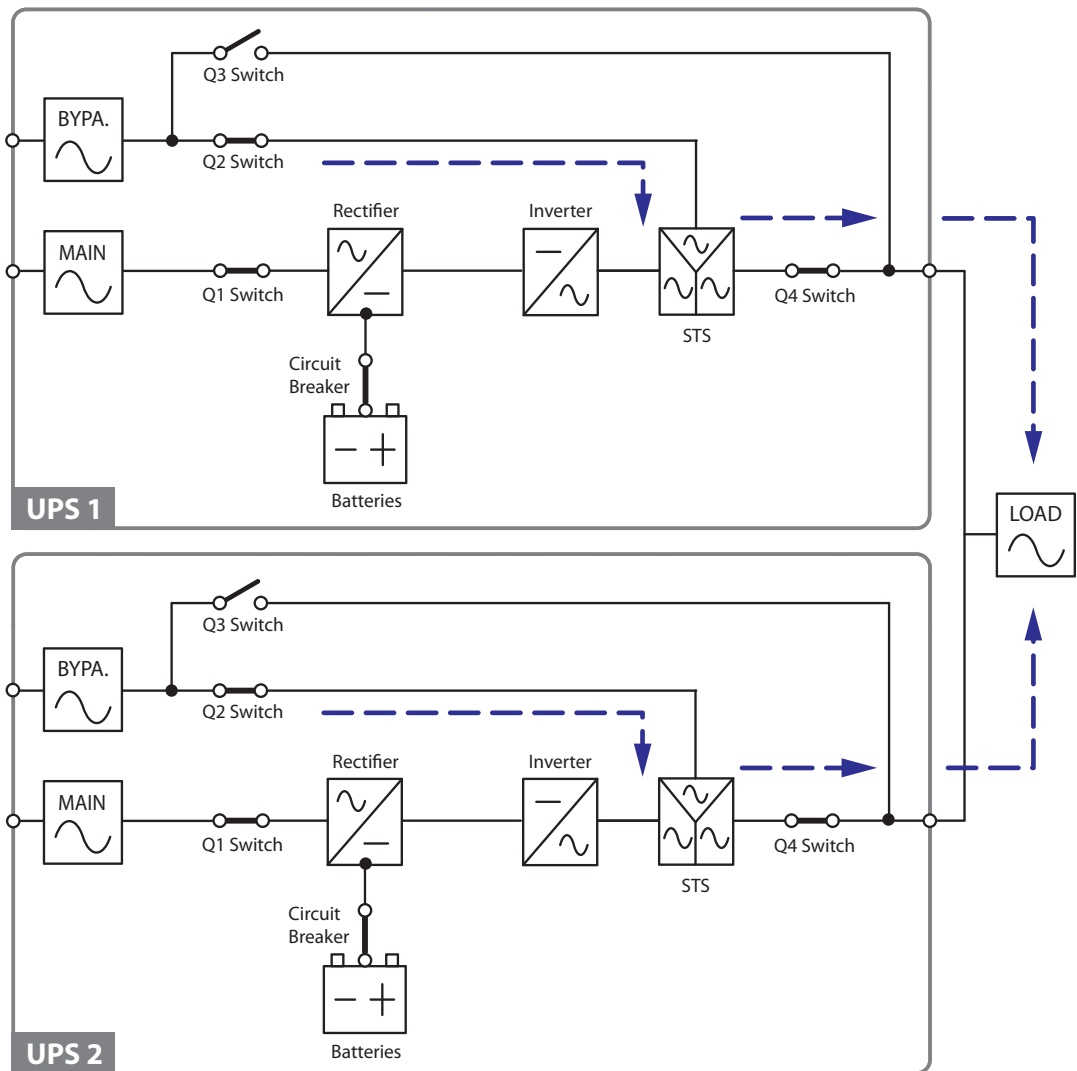

(Figure 3-h: Path of Electrical Power through the Parallel UPSs in Bypass Mode)

In parallel mode, when all inverters encounter abnormal situations such as over temperature, overload, short circuit, abnormal output voltage and battery depletion, they will automatically shut themselves down to protect the UPSs' systems. Meanwhile, if all UPSs detect the bypass AC source is normal, they will automatically switch to bypass mode to protect the connected equipment loads from power interruption. The equipment loads will be equally shared by all parallel units. After abnormalities are eliminated, the UPSs will switch back to normal mode from bypass mode. During bypass mode, all parallel UPSs' LEDs illuminate as follows.

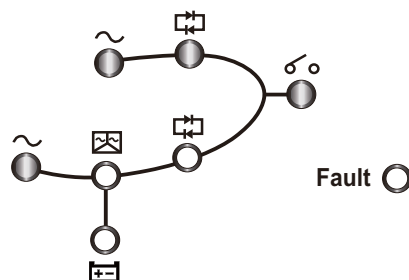

3.9 Manual Bypass Mode (Parallel)

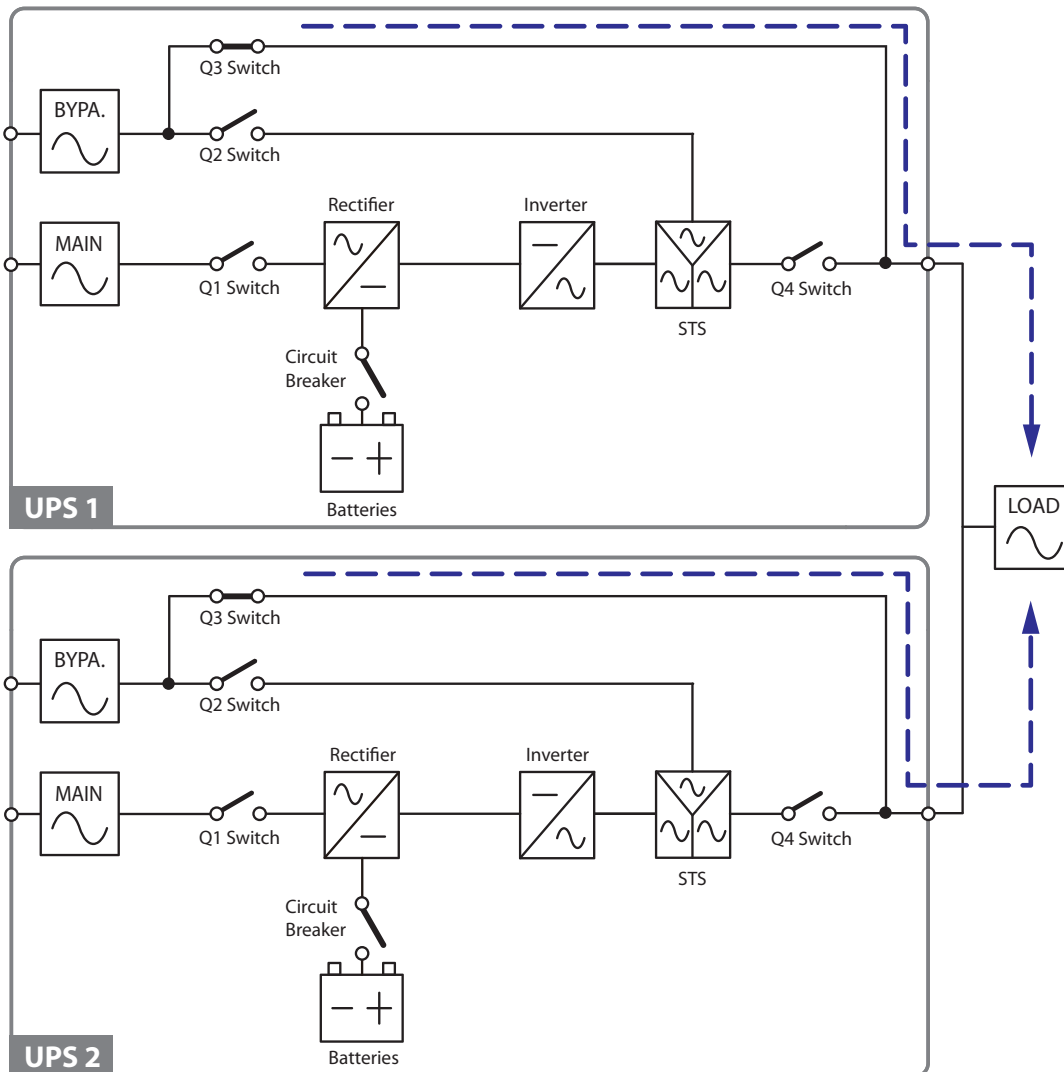

(Figure 3-i: Path of Electrical Power through the Parallel UPSs in Manual Bypass)

In parallel mode, if you want a UPS to run in manual bypass mode, please confirm that the bypass AC source is normal. After confirmation, you can manually switch all UPSs to manual bypass mode. In manual bypass mode, all power inside the UPSs is completely cut off and maintenance personnel can perform maintenance safely. The connected equipment loads will be equally supplied by the parallel units. During manual bypass mode, no LED illuminates.

NOTE

1. After the power inside all parallel UPSs has been completely cut off, there is no high voltage inside the UPSs except the wiring terminals and the Manual Bypass Switch (Q3). Do not touch the wiring terminals or Manual Bypass Switch (Q3) to avoid electrical shock.
2. For parallel UPSs, if you want to turn off one of the parallel UPSs for maintenance, please make sure the connected equipment loads will not exceed the remaining parallel units' total capacity.

3.10 Hot Standby Redundancy

To provide customers more application choices, the DPS series UPS is designed with a hot standby redundancy function. The design is to connect the output of UPS 1 to the bypass AC source of UPS 2.

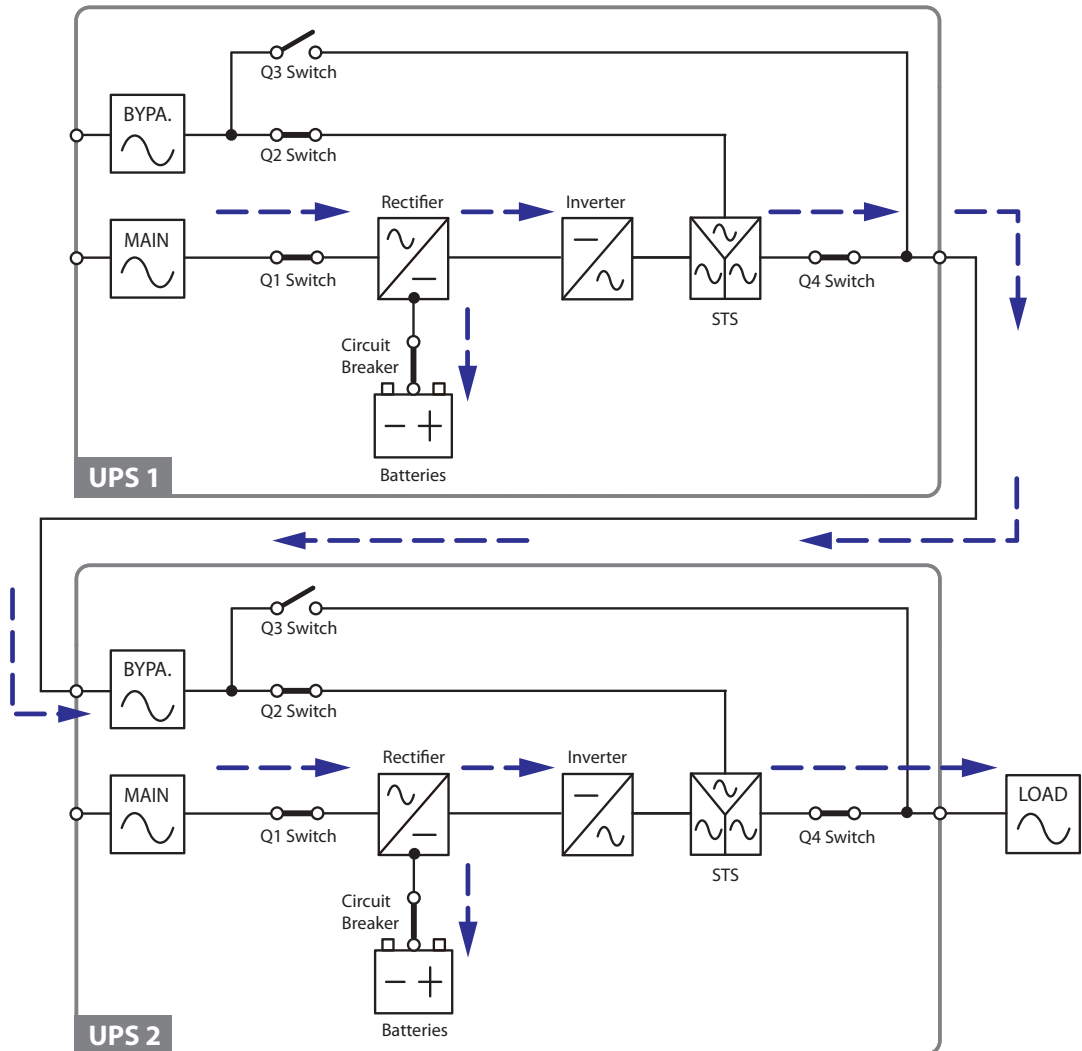

(Figure 3-j: Path of Electrical Power through the Parallel UPSs in Hot Standby Redundancy Mode)

In normal condition, it is the UPS 2 inverter that supplies power to the equipment loads. Both UPS 1 & UPS 2 LEDs illuminate as follows.

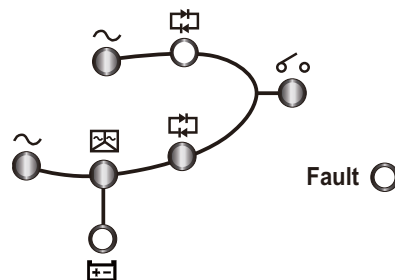

When the UPS 2 inverter becomes abnormal, the UPS 2 will automatically transfer to bypass mode and the UPS 1 inverter will supply power to the equipment loads. The UPS 1 & UPS 2 LEDs illuminate as follows.

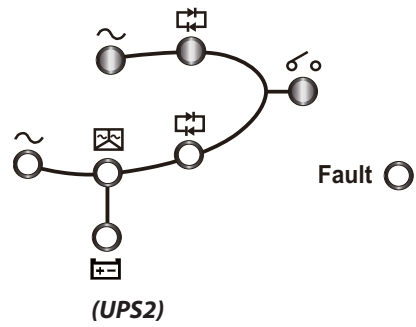
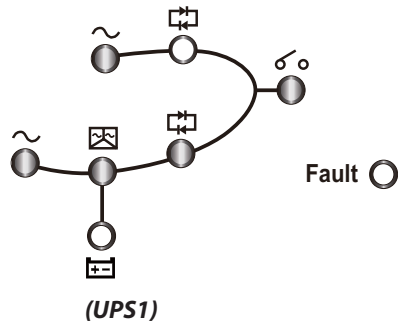

3.11 Common Battery

To save on your costs and installation space, parallel UPSs can share Delta external battery cabinets (optional). Please see **Figure 3-k** for two parallel UPSs sharing one Delta external battery cabinet.

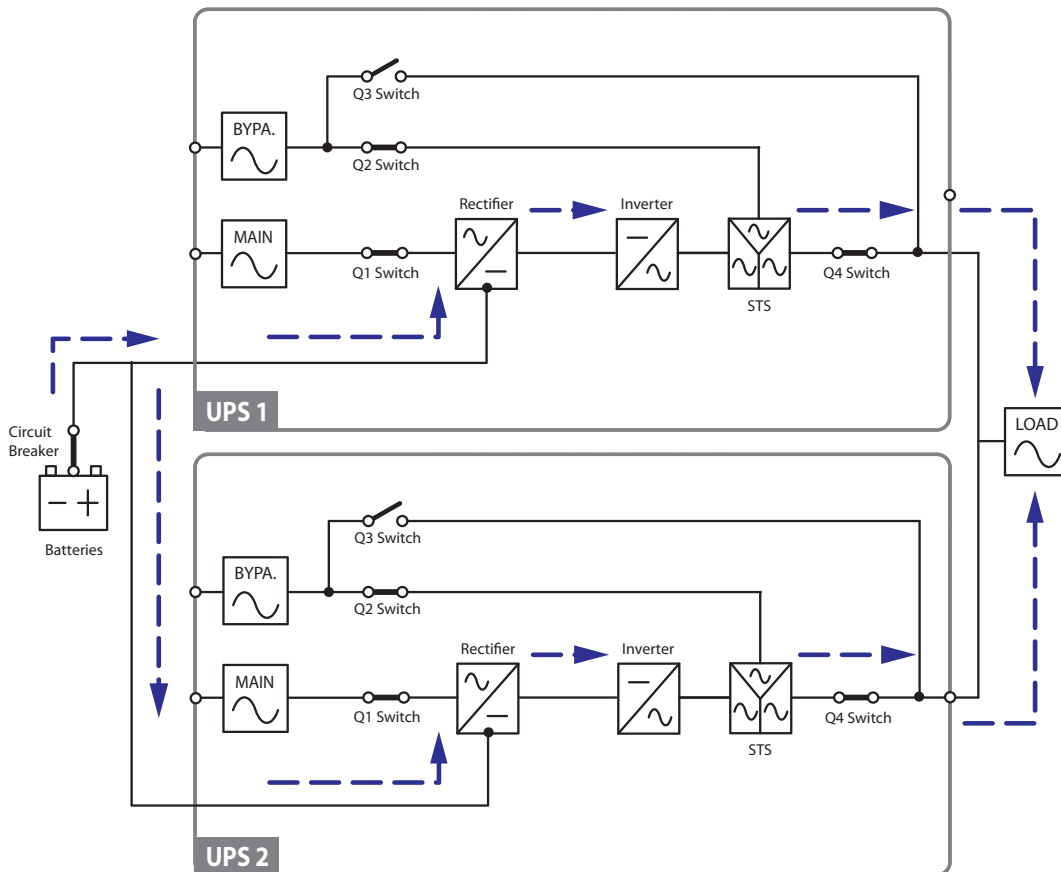

(Figure 3-k: Path of Electrical Power through the Parallel UPSs in Common Battery Mode)

If parallel UPSs share Delta external battery cabinets (optional), you should use the control panel to set up 'TYPE(AH)', 'BAT STRINGS', 'FLOAT CHARGE VOLT(V)', 'BOOST CHARGE VOLT(V)', and 'CHARGE CURRENT'. Please refer to **7.5.3 Battery Setup** and **7.5.4 Charger Setup**.



Please note that you should set each UPS float voltage (default: 272v) the same, each UPS boost voltage (default: 288v) the same, and set each UPS charge current even. For example, when two UPSs are paralleled, they share one Delta battery cabinet (optional), battery type is 120AH, and you want to set the Delta battery cabinet's charge current as 20A. You should set each UPS 'TYPE(AH)' as 60AH, 'BAT STRINGS' as 1, and 'CHARGE CURRENT' as 10A.

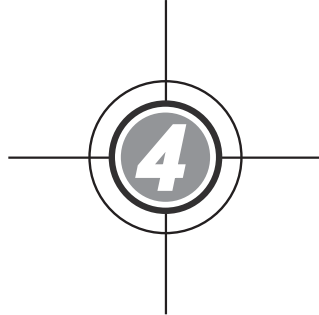

Communication Interfaces

4.1 Card Slots

4.2 RS232 Port

4.3 Dry Contacts

4.4 Parallel Ports

4.5 Dip Switch

4.6 Output Dry Contacts

Communication interfaces include card slots, an RS232 port, dry contacts, parallel ports, a dip switch, and output dry contacts as shown in the figure below.

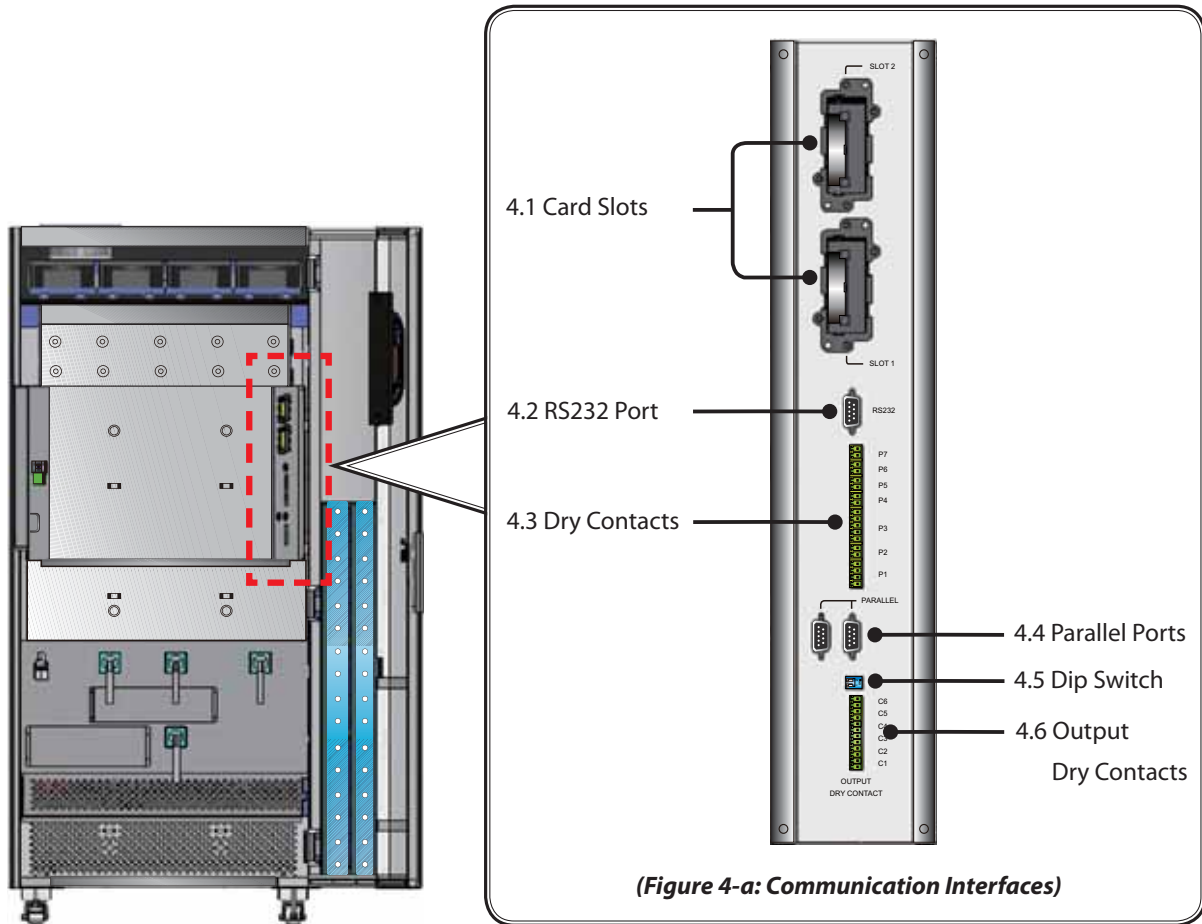

4.1 Card Slots

The UPS provides two card slots. You can choose optional cards to monitor the UPS or to enhance the UPS function. You can use the two slots at the same time and it won't influence the function of the RS232 port. The list of optional cards is shown in the table below.

Optional Card	Function
SNMP Card	Helps you remotely monitor the status of the UPS via internet.
Relay I/O Card	Increases the quantity of dry contacts.
ModBUS Card	Lets the UPS have ModBus communication.



If you need any optional card, please contact your local dealer or customer service.

4.2 RS232 Port

You can use the provided RS232 cable to connect the UPS with a computer and use the included CD to install the UPSentry Smart 2000 software to record UPS power events, set up alarms, and shut down the UPS safely. You can also download the free InsightPower Man-

ager software from the website, <http://59.125.232.140>, to monitor several UPSs placed in a computer room or a factory to facilitate centralized control.

4.3 Dry Contacts

The UPS provides seven sets of dry contacts to receive external information of devices connected to the dry contacts. The function of each dry contact is described as follows.

P1: Input dry contacts (two sets)

P2: REPO

P3: External battery cabinet status detection

P4: External battery cabinet temperature detection 1

P5: External battery cabinet temperature detection 2

P6: External battery cabinet temperature detection 3

P7: External battery cabinet temperature detection 4

- **P1: Input dry contacts (two sets)**

In normal conditions, the dry contacts are normally open. If you need to modify the default settings, please contact your local dealer.

Default Setting:
Generator Power
Supply Signal

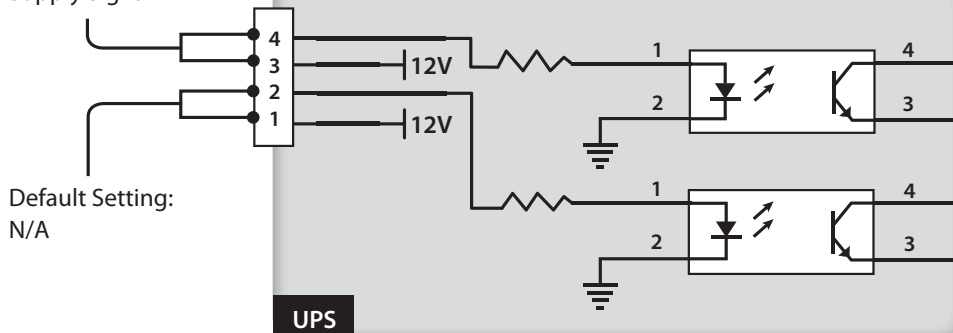

(Figure 4-b: Input Dry Contacts (Two Sets))

- **P2: REPO**

This dry contact provides you with a quick and convenient interface to safely shut down the UPS when an emergency occurs. Connect this dry contact to a user-supplied switch and you can remotely shut down the UPS. The REPO dry contact is normally open in normal circumstances.

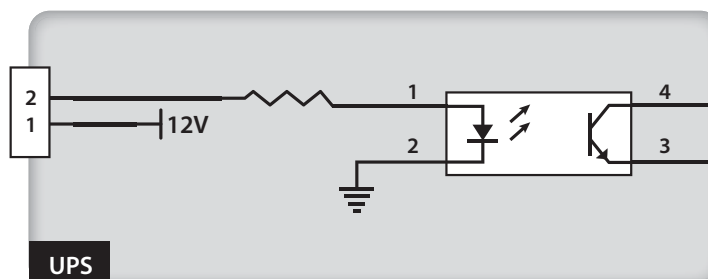

(Figure 4-c: Dry Contacts for REPO)

- **P3: External Battery Cabinet Status Detection**

You can purchase a battery cabinet status sensor cable shown in the figure below to connect the UPS and one Delta external battery cabinet and use it to detect the status of the battery cabinet. Please note that the sensor cable is only applicable to the Delta external battery cabinet.



NOTE

If you want to buy the battery cabinet status sensor cable, please contact your local dealer or customer service.

- **P4~P7: External Battery Cabinet Temperature Detection**

You can purchase a battery cabinet temperature sensor cable shown in the figure below to connect the UPS and one Delta external battery cabinet and use it to detect the temperature of the battery cabinet. Please note that the sensor cable is only applicable to the Delta external battery cabinet, and you can use at maximum four temperature sensor cables to connect the UPS and four Delta external battery cabinets.



NOTE

If you want to buy the battery cabinet temperature sensor cable, please contact your local dealer or customer service.

4.4 Parallel Ports

The two parallel ports are for UPS parallel communication. UPSs (at maximum eight) with the same capacity, voltage and frequency can be coupled via the provided parallel cable to run in parallel mode.



WARNING:

1. The provided parallel cable is placed in the accessory package. Using other types of cables to connect the UPSs may cause malfunctions.
2. The provided parallel cable's pin design is one-to-one, not crossed.

4.5 Dip Switch

When you parallel UPSs, you need to set up the dip switch to activate parallel function. Please see **6.6 Normal Start-up Procedures (Parallel Units)** for dip switch settings.

4.6 Output Dry Contacts

The UPS provides six sets of programmable output dry contacts for you to receive UPS events. The output dry contacts are normally open and have no default setting. There are nineteen events for you to select to set up the output dry contacts via the Delta Insight-Power Manager software. Please refer to the table below for the twenty events.

Item	Event	Description
1	Load on inverter	The UPS works in normal mode.
2	Load on bypass	The UPS works in bypass mode.
3	Battery discharge/ Main input NOK	When the main AC source fails, the batteries supply power to the equipment loads.
4	Low battery	When the UPS runs in battery mode, battery voltage is lower than the setup limit, 220Vdc.
5	Bypass input NOK	The bypass voltage, frequency or phase sequence is abnormal.
6	Battery test fail or battery missing	During the battery test, the battery voltage is out of the setup limit.
7	Internal communication failure	Power unit's internal communication is abnormal.
8	External parallel communication loss	In parallel mode, parallel communication is abnormal.
9	Output overload warning/ shutdown	The UPS is overloaded or the UPS shuts down to let the bypass supply power to the equipment loads.
10	Power module fault shutdown	The power unit has abnormalities and it shuts down the UPS to let the bypass supply power to the equipment loads.
11	Power module warning	The power unit has abnormalities but the UPS still runs in normal mode.
12	EPO activated	The EPO button was pressed to urgently power off the UPS.
13	Load on manual bypass	The Manual Bypass Switch (Q3) is turned on and the UPS transfers to manual bypass mode.
14	Battery cabinet over temperature warning/ shutdown	The external battery cabinet's temperature is too high.
15	Abnormal inverter voltage	The output voltage is too high or too low.
16	Battery needs replacement	Battery replacement date is due.

17	Bypass over temperature warning/ shutdown	Bypass static switch temperature is too high.
18	Bypass static switch fault	The bypass static switch has open/ short issue.
19	General alarm	When any UPS alarm occurs.

• **Output Dry Contacts Design**

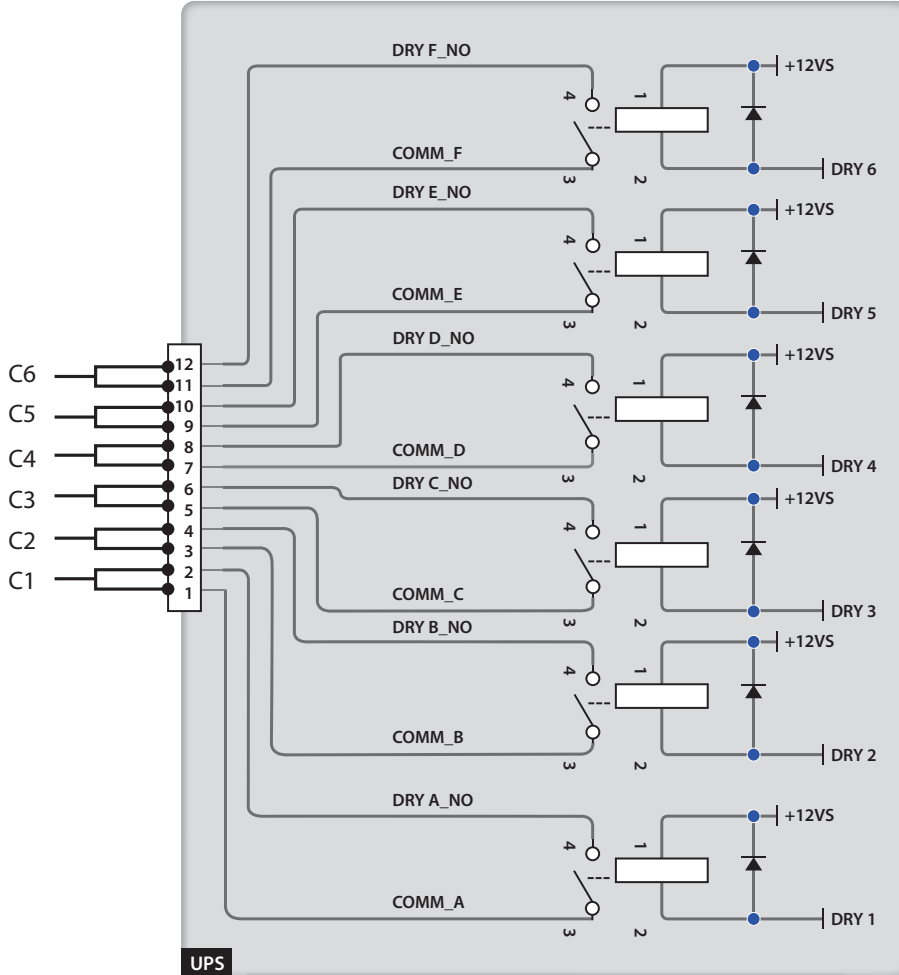

(Figure 4-d: Output Dry Contacts Design)

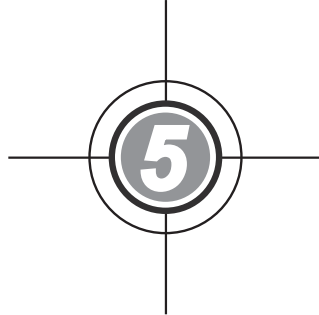

Installation and Wiring

5.1 Before Installation

5.2 Installation Environment

5.3 Transportation

5.4 Fixing the UPS

5.5 Wiring

5.6 Delta External Battery Cabinet
(Optional)

5.1 Before Installation

Due to different installation environments, it is highly recommended that you read this user manual before installation. Only authorized Delta engineers or service personnel can perform installation and maintenance. If you want to install the UPS by yourself, installation must be under the supervision of authorized Delta engineers or service personnel. If you use a forklift or other equipment to move the UPS, please make sure its load bearing is sufficient. Please refer to **Table 5-1**.

5.2 Installation Environment

- Install the UPS indoors. Do not place it outdoors.
- Make sure that transportation routes (e.g. corridor, door gate, elevator, etc.) and installation area can accommodate and bear the weight of the UPS, Delta external battery cabinets (optional) and forklifts. Please see **Table 5-1 & 5-2** for floor weight loading information.

Table 5-1: DPS UPS Floor Weight Loading Table

DPS UPS	
Rating (kVA)	160/ 200
Weight (Kg)	682
Weight Loading (kg/m ²)	927.6

Table 5-2: Delta External Battery Cabinet Floor Weight Loading Table

Delta External Battery Cabinet (Optional)/ (Including 40 batteries)	
Capacity (Ah)	12V/ 120Ah
Weight (kg)	1810
Weight Loading (kg/m ²)	2366

- Keep the installation area clean. Please note that wiring routes must be hermetic to prevent possible damage from rodents.
- Ensure that the installation area is big enough for maintenance and ventilation. Since the fans of the UPS ventilate from bottom to top (please see **Figure 5-a**) and Delta external battery cabinets (optional) must be placed next to the UPS, we suggest that you:
 1. Keep a distance of 100cm from the front of the UPS for maintenance and ventilation.
 2. Keep a distance of 10cm from the back of the UPS for ventilation.
 3. Keep a distance of 100cm from the top of the UPS for maintenance and ventilation.

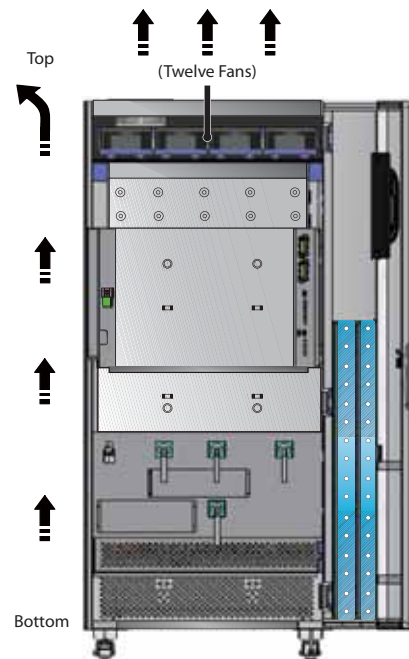

(Figure 5-a: Fans Ventilation Direction)

- Keep the installation area's temperature around 25°C and humidity within 90%. The highest operating altitude is 3000 meters.
- For safety concerns, we suggest that you:
 1. Equip surroundings of the installation area with CO₂ or dry powder fire extinguishers.
 2. Use fireproof materials to construct the walls, floors and ceilings of the installation area.
- Do not allow unauthorized personnel to enter the installation area. Assign specified personnel to keep the UPS key.



WARNING: Do not use air conditioners or similar equipment to blow into the top of the UPS and hinder ventilation.

5.3 Transportation

- At the bottom of the UPS, there are four casters to help you to move the UPS to a designated area. Before you move the UPS, please turn the four levelers counterclockwise to raise them off the ground. This protects the levelers from damage when moving the UPS. Please use sufficient manpower (at least six people) and equipment (e.g. forklift) to carefully move the UPS from pallet to ground. Please pay attention to the movement of the casters to avoid accidents.



WARNING: The UPS is fixed on the pallet with four balance supports. When taking apart the four balance supports (including twenty bolts) from the UPS, please pay attention to the movement of the casters to avoid accidents. Please refer to the **unpacking guide** attached to the UPS external wooden box for location of balance supports.

- The casters are designed to move on level ground. Do not move the UPS on an uneven surface. This might cause damage to the casters or tip the UPS which could damage the unit.
- After the UPS has been removed from the pallet to ground, we suggest that at least three people move the UPS to the installation area. One person use their hands to hold a lateral side of the UPS, one person hold the other lateral side of the UPS with their hands, and one person use their hands to push the UPS either from the front side or from the backside to move the unit to the installation area and avoid tipping the UPS.
- If you need to move the UPS over a long distance, please use appropriate equipment like a forklift. Do not use the UPS casters to move the unit over a long distance.

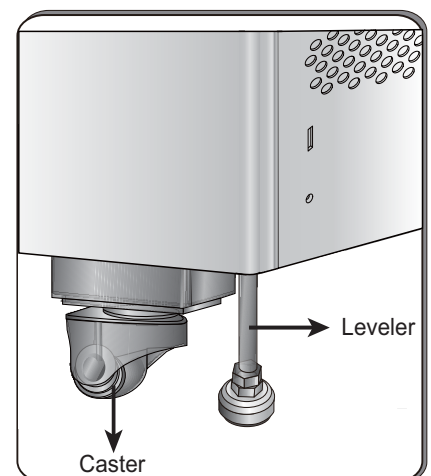

(Figure 5-b: Caster and Leveler)

5.4 Fixing the UPS

- STEP 1:** Before fixing the UPS in a designated area, please double check whether the area's floor weight loading is sufficient to bear the UPS and Delta external battery cabinets (optional) to avoid accidents. Please refer to **Table 5-1 and Table 5-2**.
- STEP 2:** After moving the UPS to the designated area, please use a #17 wrench to stabilize the four levelers on the floor. Please note that the UPS must stand on the floor firmly and levelly without any tipping.
- STEP 3:** To prevent possible damage from rodents, please take the provided four rodent shields (including 14 M4 screws) out of the accessory package and install them on the UPS.
- STEP 4:** Use the supplied four M4 screws to fix one long rodent shield with two rodent short shields. Please see **Figure 5-c**.
- STEP 5:** Use the supplied three M4 screws to fix the assembled rodent shields (Π shape) on the UPS. Please see **Figure 5-c**.

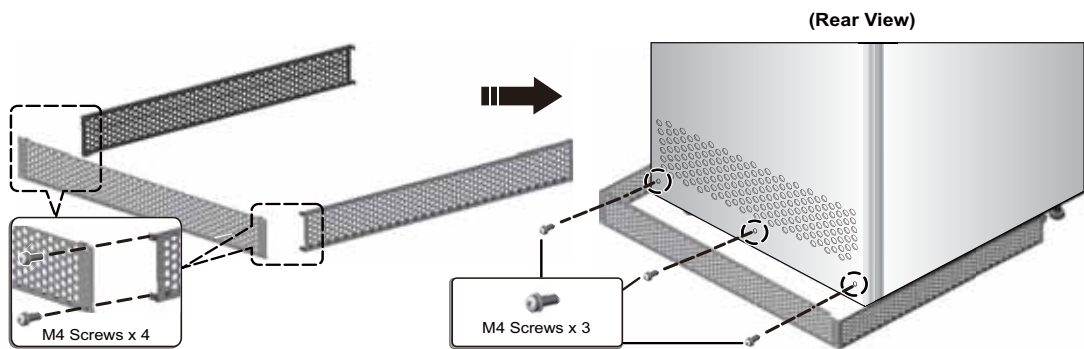

(Figure 5-c: Install the Rodent Shields at the Rear of DPS)

- STEP 6:** Use No. 10 and No. 19 wrenches and two balance supports (including ten bolts) that have been removed from the UPS during the unpacking process to fix the back of the UPS on the ground. Please see **Figure 5-d**.

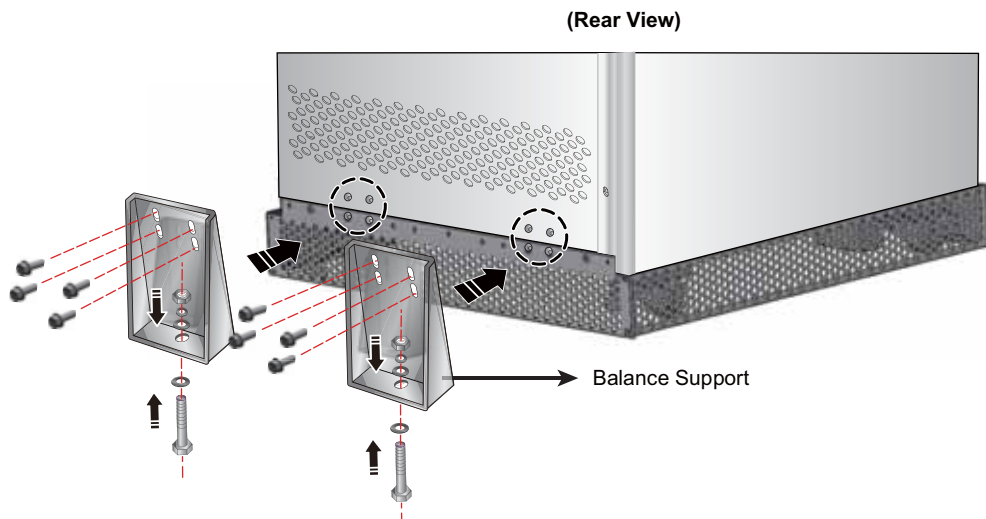

(Figure 5-d: Install the Balance Supports at the Rear of DPS)

STEP 7: Use No. 10 and No. 19 wrenches and two balance supports (including ten bolts) that have been removed from the UPS during the unpacking process to fix the front of the UPS on the ground. Please see **Figure 5-e**.

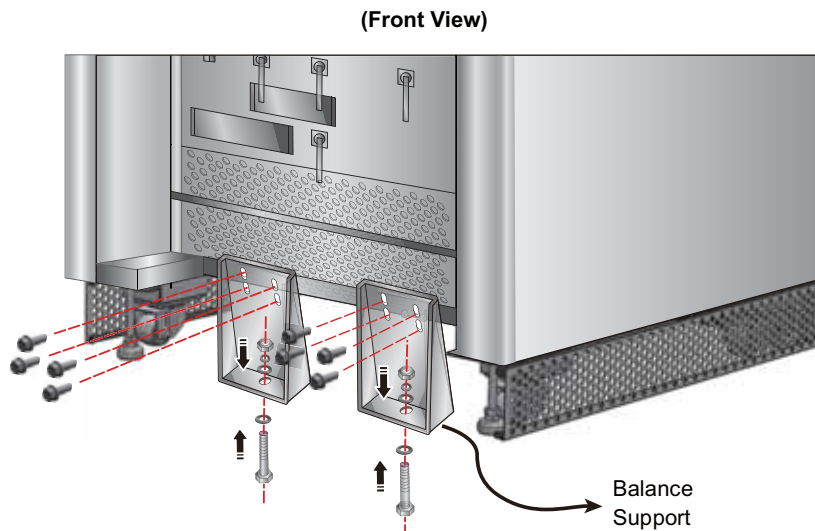

(Figure 5-e: Install the Balance Supports at the Front of DPS)

STEP 8: Follow **5.5 Wiring** to perform wiring.

STEP 9: After wiring, fix the remaining long rodent shield on the front of the UPS using the provided three M4 screws ❶, and use the remaining four M4 screws ❷ to fix the long rodent shield with the two short rodent shields shown. Please see **Figure 5-f**.

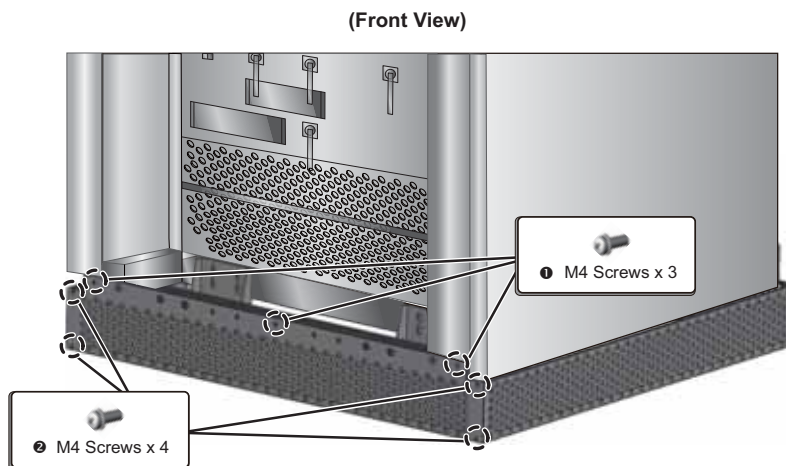

(Figure 5-f: Install the Rodent Shields at the Front of DPS)



WARNING: If you don't use the balance supports to fix the UPS, the unit might topple over. For safety concerns, please use the balance supports to fix the UPS to the floor.

5.5 Wiring

5.5.1 Pre-wiring Warnings

- Before wiring or making any electrical connection, make sure the power supplied to the input and output of the UPS is completely cut off.
- Check that the size, diameter, phase, and polarity of each cable that needs connecting to the UPS is correct. Please refer to **Table 5-3**.

Table 5-3: Cable Information:

UPS Rating (kVA)	160	200
I/P Voltage (V)	220/380	220/380
O/P Voltage (V)	220/380	220/380
I/P Switch (A)	315	400
I/P Cable (mm ²)	50mm ² x 2 PCS	70mm ² x 2 PCS
Bypass Switch (A)	315	400
Bypass Cable (mm ²)	50mm ² x 2 PCS	70mm ² x 2 PCS
UPS Output Switch (A)	315	400
O/P Cable (mm ²)	50mm ² x 2 PCS	70mm ² x 2 PCS
Battery Cable (mm ²)	50mm ² x 2 PCS	70mm ² x 2 PCS
Battery Fuse (A)	600	600
Grounding Cable (mm ²)	50mm ² x 2 PCS	70mm ² x 2 PCS



NOTE

1. Please refer to national and local electrical codes for acceptable non-fuse breakers and cable size.
2. In accordance with **National Electrical Codes (NEC)**, please install a suitable conduit and bushing.
3. Cables with PVC material and with temperature resistance up to 105°C are suggested.
4. The tightening torque for M8 screws should be 150 ±5Kgf.cm, and for M10 screws, 250 ±5Kgf.cm.

- If the input and output of the UPS is a Y connection, do not connect the UPS neutral (N) with the ground (⊕). Any wiring diagram shown in **Figure 5-k**, **Figure 5-l**, **Figure 5-m**, and **Figure 5-n** is called a Y connection.
- If there is a floating voltage between the input power's neutral (N) and the ground (⊕), and you require that the VNG of the UPS should be zero, we suggest that you install an isolation transformer in front of the input side of the UPS, and connect the UPS neutral (N) with the ground (⊕).

- **AC power source connection:**

Three phases (R/ S/ T) of the AC power source must be in positive phase sequence, and R, S, T and N cables of the AC power source must be connected to the 'R', 'S', 'T' and 'N' interfaces marked in the Main Input Block and the Bypass Input Block accordingly.

- **External battery cabinet connection:**

Connect positive and negative poles and the neutral terminal of an external battery cabinet to the '+', '-' and 'N' interfaces marked in the Battery Input Block. Do not make a wrong connection.

- **External battery cabinet grounding:**

Connect an external battery cabinet's grounding terminal to the terminal of ground (⊕). Do not connect the grounding terminal of the external battery cabinet to any other grounding system.

- The terminal of ground (⊕) must be grounded.



WARNING: Wrong wiring will cause damage to the UPS and electric shock.

5.5.2 Single Input/ Dual Input Modification



WARNING: Only authorized Delta engineers or service personnel can modify single input/ dual input setup.

The UPS default setting is single input. If you want to modify it into dual input, please remove the panel marked by the red square shown in the figure below.

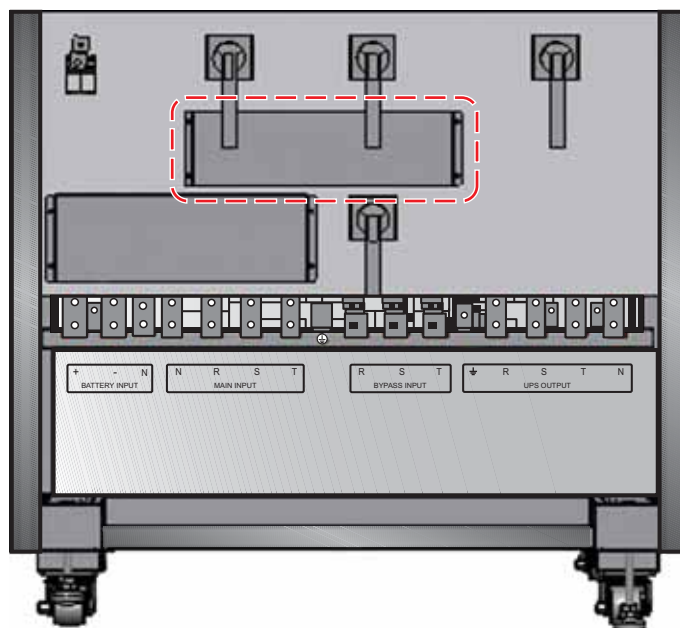

(Figure 5-g : Panel Location)

After removing the panel, please use a socket wrench to remove the three copper bars shown in the figure below to modify the UPS into dual input.

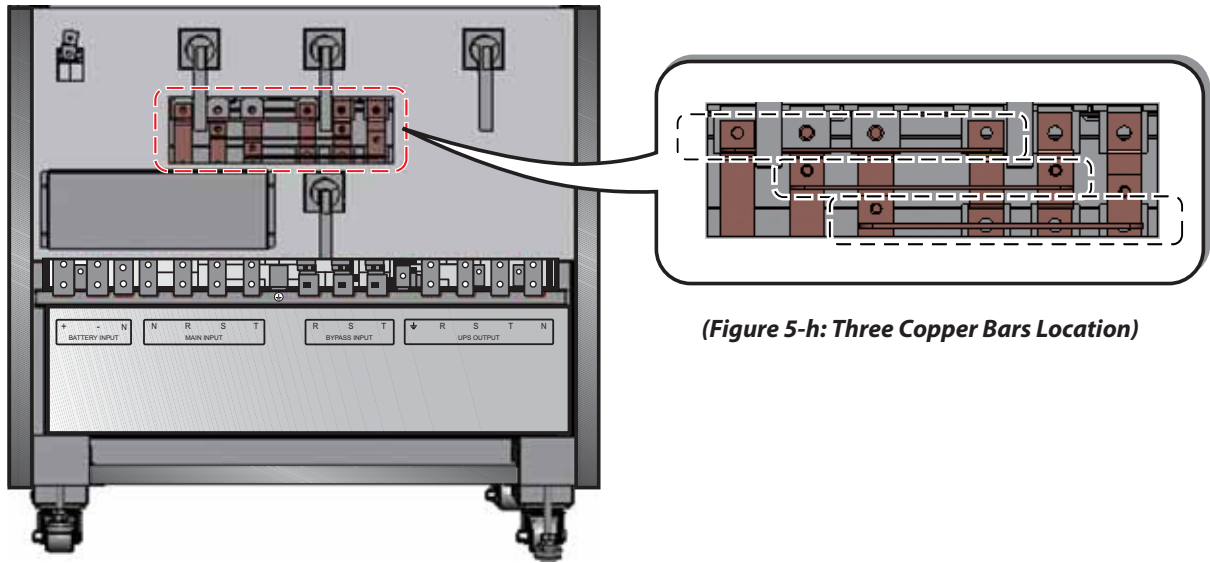

(Figure 5-h: Three Copper Bars Location)

NOTE 

If you want to modify the UPS from dual input into single input, please use the socket wrench to reinstall the three copper bars, and replace the panel.

5.5.3 Single Unit Wiring



NOTE 

Before wiring, please read **5.5.1 Pre-wiring Warnings**.

- **Single Input (Single Unit)**

When there is only one AC power source, single unit wiring procedures are as follows.

1. Open the front door, take down the panel that covers the wiring terminal block and you will see the wiring terminal block shown in **Figure 5-i**.
2. The wiring terminal block includes:

No.	Item	Function	Description
①	Battery Input Block	Connects an external battery cabinet	Includes positive (+), negative (-) and neutral (N) terminals.
②	Main Input Block	Connects the main AC source	Includes three phases (R, S, T) and neutral (N) terminals.
③		For UPS grounding (safety)	Includes one grounding terminal.
④	Bypass Input Block	Connects the bypass AC source	Includes three phases (R, S, T) terminals.
⑤	UPS Output Block	Connects the equipment loads	Includes three phases (R, S, T), one neutral (N) and one grounding () terminals.

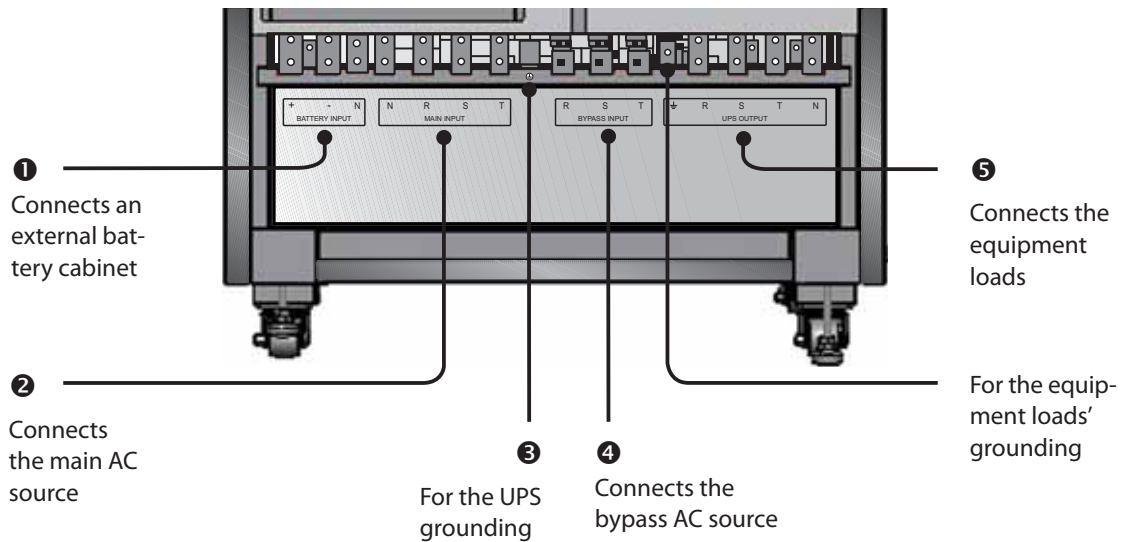

(Figure 5-i: Wiring Terminal Block)

NOTE

Please connect the bypass AC source's neutral to the neutral (N) terminal of the Main Input Block.

3. The UPS rating voltage is 220/380Vac, 230/400Vac or 240/415Vac.
4. The battery rating voltage is ± 240 Vdc.
5. Make sure the Main Input Switch (Q1) and Bypass Switch (Q2) are in the 'OFF' position.
6. Make sure the Manual Bypass Switch (Q3) is in the 'OFF' position.
7. Make sure the UPS Output Switch (Q4) is in the 'OFF' position. Please see **Figure 5-j** for switch location.

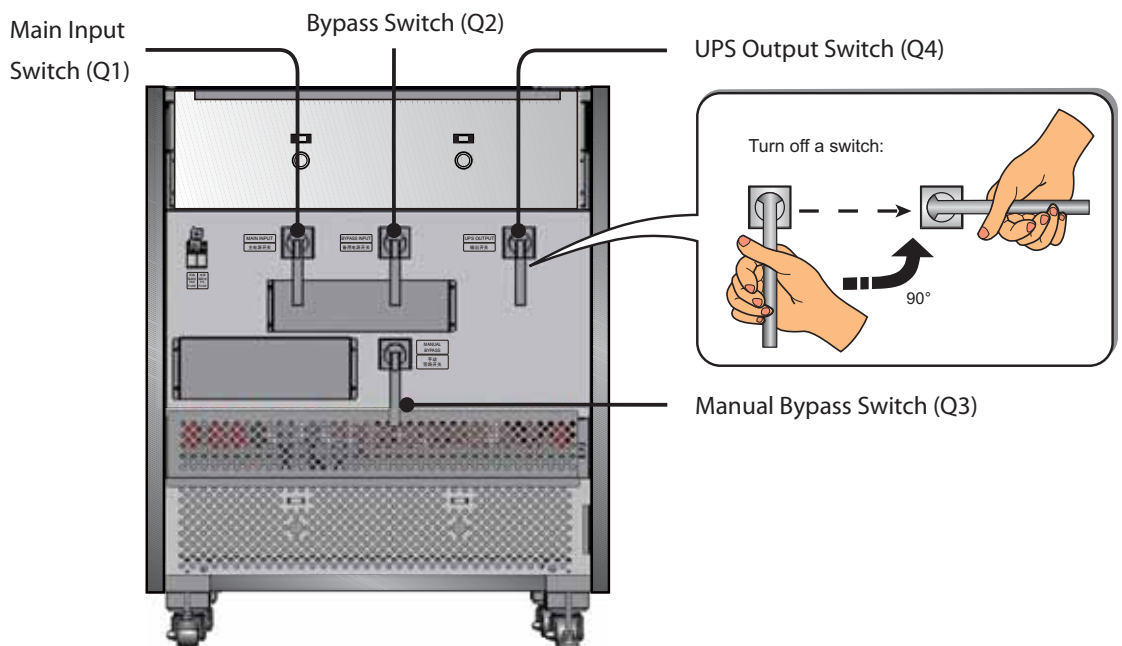

(Figure 5-j: Switches Location and Turn off a Switch)

8. Follow UPS model No. to select appropriate input/ output cables. Please refer to **Table 5-3**.
9. Connect the main AC source/ UPS output/ external battery cabinet cables to the wiring terminal block. Please see **Figure 5-k**.
10. Ground the UPS. Please see **Figure 5-k**.

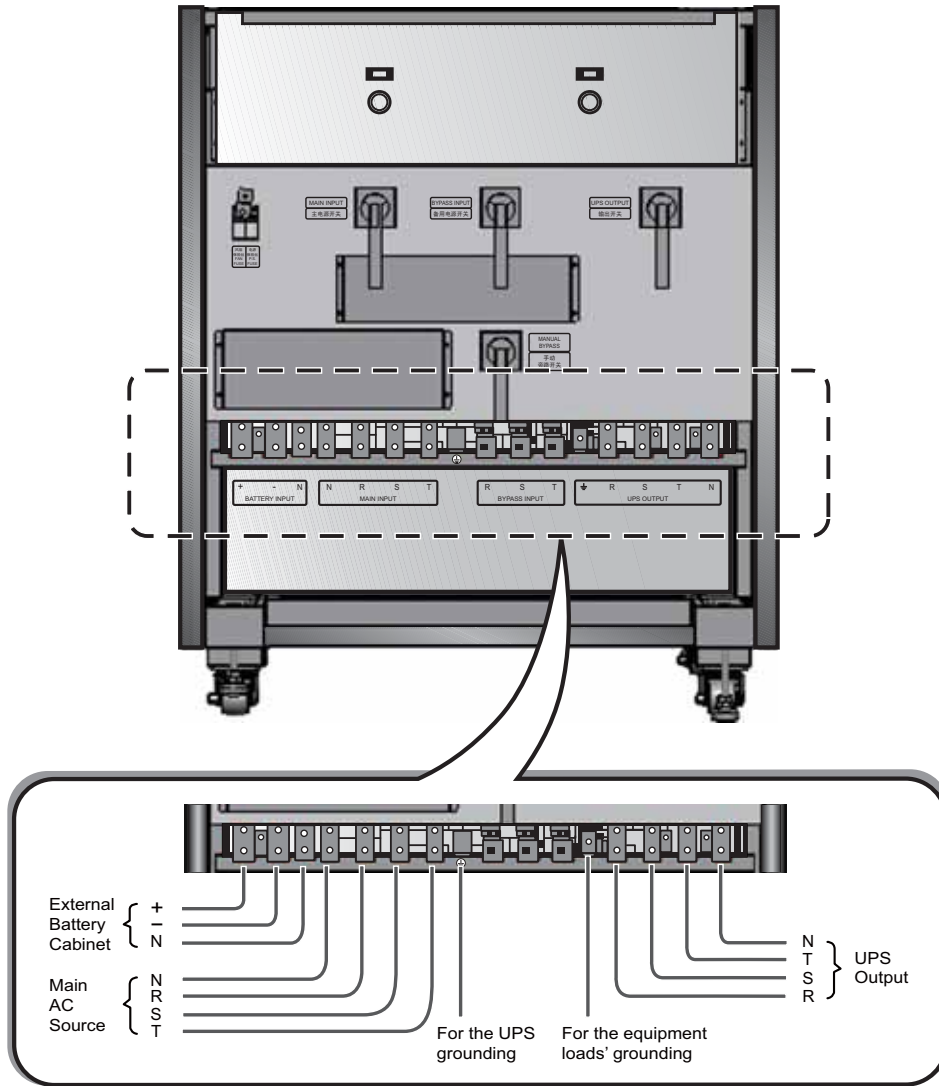

(Figure 5-k: Single Unit Single Input Wiring Diagram)

● **Dual Input (Single Unit)**

When there are two AC power sources, single unit wiring procedures are as follows.

1. Follow **5.5.2 Single Input/ Dual Input Modification** to modify the UPS into dual input.
2. Refer to the procedures 1~8 stated in the section of **Single Input (Single Unit)**.
3. Connect the main AC source/ bypass AC source/ UPS output/ external battery cabinet cables to the wiring terminal block. Please see **Figure 5-l**.
4. Connect the bypass AC source's neutral to the neutral (N) terminal of the Main Input Block.
5. Ground the UPS.

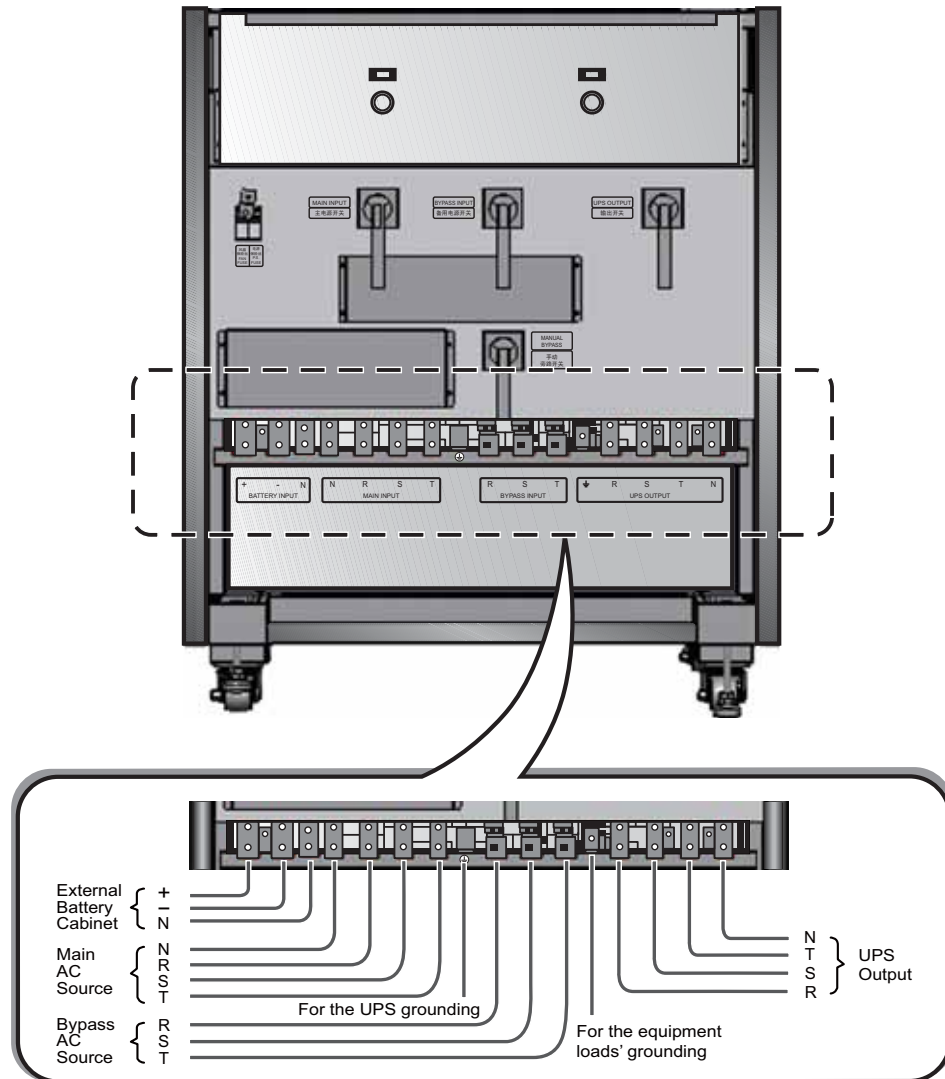

(Figure 5-1: Single Unit Dual Input Wiring Diagram)

5.5.4 Parallel Units Wiring



Before wiring, please read **5.5.1 Pre-wiring Warnings**.

- **Single Input (Parallel Units)**

When there is only one AC power source, parallel units' wiring procedures are as follows.

1. Follow the procedures 1~8 stated in the section of **Single Input (Single Unit)**.
2. Connect the main AC source/ bypass AC source/ UPS output/ external battery cabinet cables to the wiring terminal block. Please see **Figure 5-m**.
3. Connect the bypass AC source's neutral to the neutral (N) terminal of the Main Input Block.
4. Use the provided parallel cable to connect the parallel ports on the parallel units.

5. Ground the parallel UPSs. Please see **Figure 5-m** for parallel port location.



WARNING:

1. When UPSs are paralleled, the length of each unit's input cables plus output cables must be equal. This ensures that the parallel UPSs can equally share the equipment loads in bypass mode.
2. Only UPSs with the same capacity, voltage and frequency can be paralleled; otherwise, parallel functions will fail.

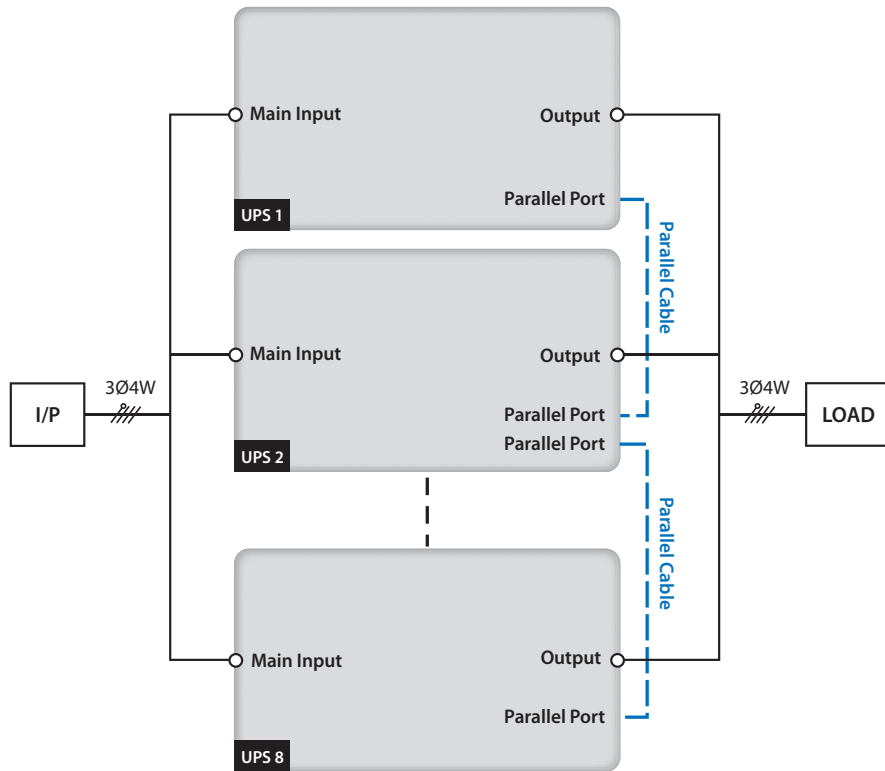

(Figure 5-m: Parallel Units Single Input Wiring Diagram)

• **Dual Input (Parallel Units)**

When there are two AC power sources, parallel units' wiring procedures are as follows.

1. Follow **5.5.2 Single Input/ Dual Input Modification** to modify the parallel UPSs into dual loop.
2. Follow the procedures 1~8 stated in the section of **Single Input (Single Unit)**.
3. Connect the main AC source/ bypass AC source/ UPS output/ external battery cabinet cables to the wiring terminal block. Please see **Figure 5-n**.
4. Connect the bypass AC source's neutral to the neutral (N) terminal of the Main Input Block.
5. Use the provided parallel cable to connect the parallel ports on the parallel units.

6. Ground the parallel UPSs. Please see **Figure 5-n** for parallel port location.

**WARNING:**

1. When UPSs are paralleled, the length of each unit's input cables plus output cables must be the same. This ensures that the parallel UPSs can equally share the equipment loads in bypass mode.
2. Only UPSs with the same capacity, voltage and frequency can be paralleled; otherwise, parallel functions will fail.

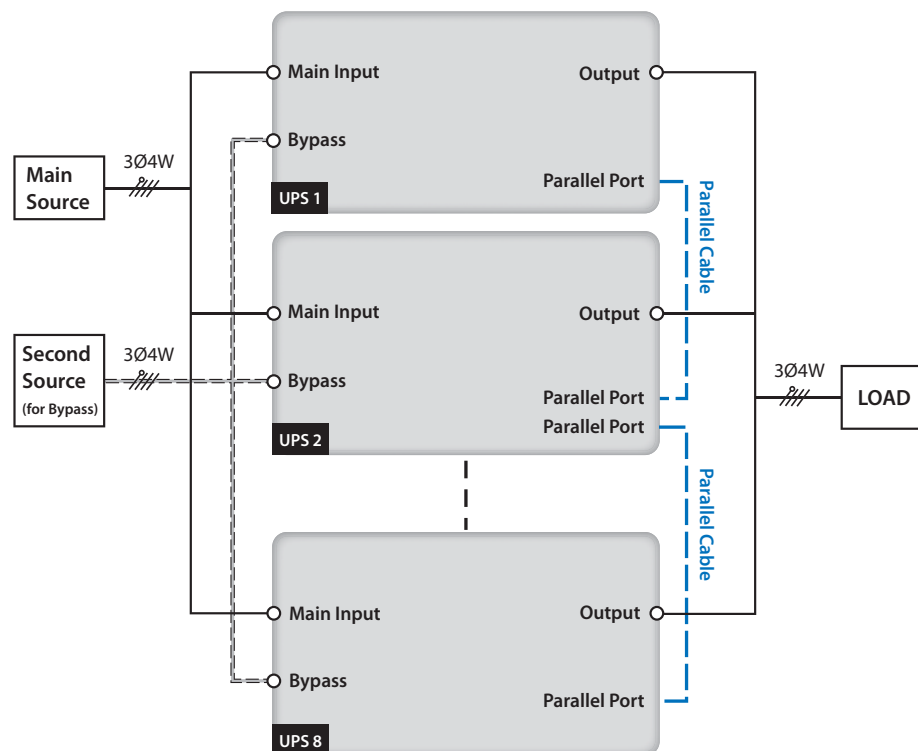

(Figure 5-n : Parallel Units Dual Input Wiring Diagram)

5.6 Delta External Battery Cabinet (Optional)

You should connect the DPS series UPS with at least one Delta external battery cabinet (optional) to ensure that the equipment loads connected are protected when a power failure occurs. You can connect at maximum four Delta external battery cabinets to the UPS.

5.6.1 Usage Warnings

- If a Delta external battery cabinet is idle for more than 6 months, please charge batteries at least 8 hours before operation. The charging procedures are as follows.
 1. Connect the UPS to an AC power source and the Delta external battery cabinet. Please see **5. Installation and Wiring**.
 2. Follow **6. UPS Operation** to turn on the UPS. After the UPS is turned on, the unit will automatically charge the batteries.



WARNING: You can connect equipment loads to the UPS only after the batteries are fully charged. Please see **5.6.1 Usage Warnings for charge voltage and charge current**. This guarantees that the UPS can provide sufficient backup power to the equipment loads connected when a power failure occurs.

- **Battery**

1. Charge voltage:
 - 1) Float voltage: $\pm 272\text{Vdc}$ (default)
 - 2) Boost voltage: $\pm 288\text{Vdc}$ (default)
2. Charge Current:
 - 1) Min: $\pm 5\text{A}$ (default)
 - 2) Max: $\pm 40\text{A}$



NOTE

If you want to modify the charge current default setting, please contact your local dealer or customer service.

3. Low Battery Shutdown: $\pm 190\sim 220\text{Vdc}$ (default: 200Vdc)



NOTE

If you want to modify the low battery shutdown default setting, please contact your local dealer or customer service.

4. The number of batteries: $12\text{V}\times 40\text{ PCS}$



NOTE

You can also choose $12\text{V}\times 38\text{ PCS}$ or $12\text{V}\times 42\text{ PCS}$ batteries. Please contact your local dealer or customer service for battery selection, installation and replacement.

- Only use the same type of batteries from the same supplier. Never use old, new and different Ah batteries at the same time.
- The number of batteries must meet UPS requirements.
- Do not connect the batteries in reverse.
- Use a voltage meter to measure whether the total voltage, after battery cabinet connection, is around $12.5\text{ Vdc} \times$ the total number of batteries.

NOTE 

1. Turn off the UPS and cut off the AC power source before performing battery/ battery cabinet replacement.
2. A battery can present a risk of electric shock and high short-circuit current.
3. Servicing of batteries and battery cabinets must be performed or supervised by qualified personnel knowledgeable in batteries, battery cabinets and required precautions. Keep unauthorized personnel away from batteries and battery cabinets.

5.6.2 Exterior, Dimensions, Bottom View with Mounting Holes and Internal Mechanisms

- Exterior Diagram

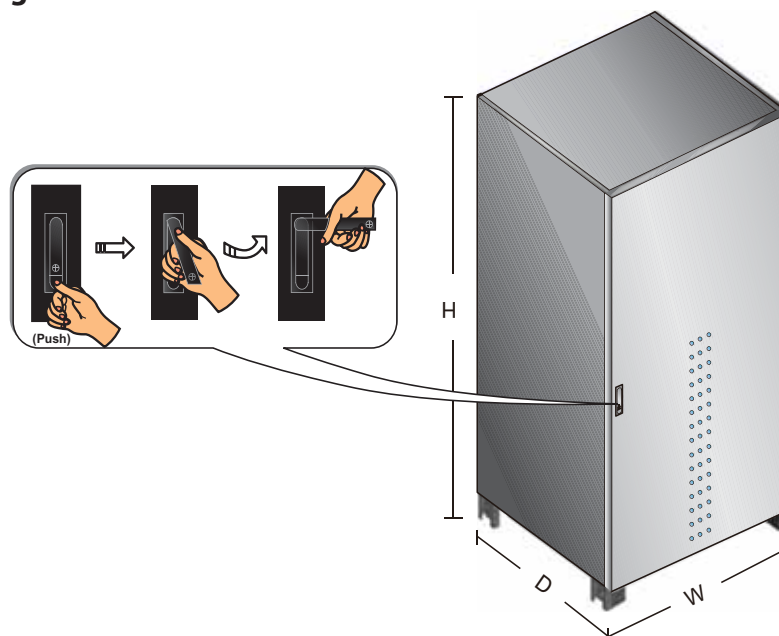

Delta External Battery Cabinet Dimensions Table

Battery Type	Width (mm)	Depth (mm)	Height (mm)
120Ah	900	850	1950

- Bottom View with Mounting Holes

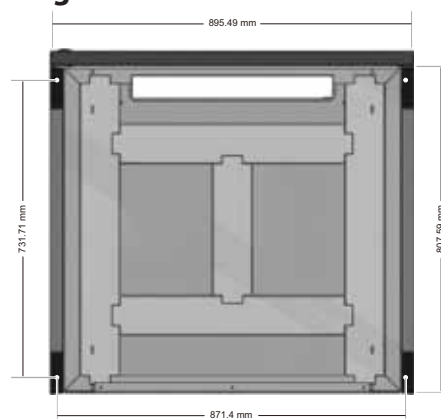

● **Internal Mechanisms**

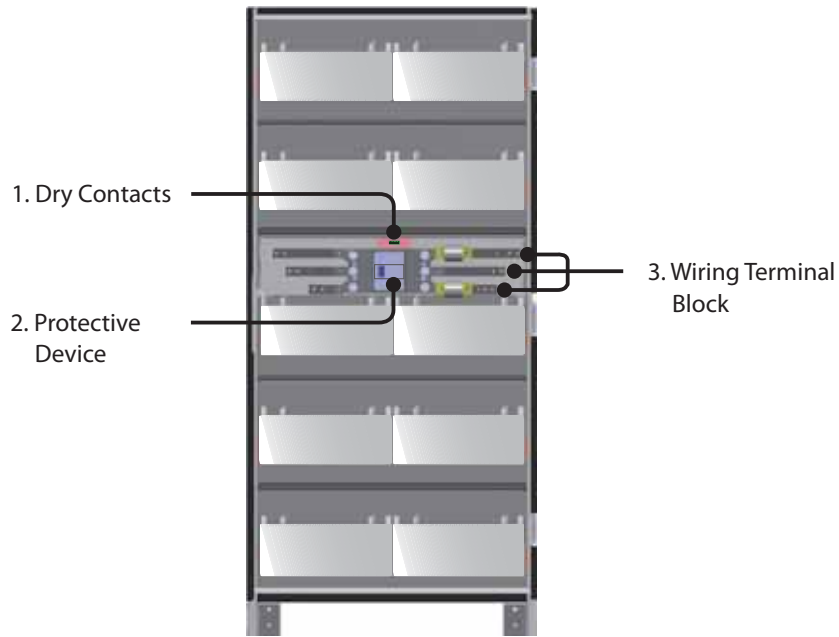

(Figure 5-o: Internal Mechanisms of a Delta External Battery Cabinet)

No.	Item	Description
1	Dry Contacts	Dry contact A and B provide the external battery cabinet's temperature and status signals to the UPS respectively. Please see 4.3 Dry Contacts for the external battery cabinet's temperature and status detection information.
		<p>1) Dry contact A: External battery cabinet temperature detection</p> <p>2) Dry contact B: External battery cabinet status detection</p>
2	Protective Device	This is a protective switch to turn on/ off battery power.
3	Wiring Terminal Block	The wiring terminal block includes positive (+), negative (-) and neutral (N) terminals. Please follow 5.6.3 Delta External Battery Cabinet Wiring to connect a Delta external battery cabinet to the UPS.

NOTE

Please refer to the **Quick Guide, User Manual, or Installation & Operation Guide** included in the package of the external battery cabinet for information on the battery cabinet's unpacking, transportation, and fixed position.

5.6.3 Delta External Battery Cabinet Wiring

Please refer to **Table 5-4 'Delta Battery Cabinet Cable Diameter and Fuse'** and **Figure 5-p 'Delta External Battery Cabinet Wiring Diagram'** to connect a Delta external battery cabinet to the UPS. Please note that only authorized Delta engineers or service personnel can perform wiring or you can perform wiring only under the supervision of authorized Delta engineers or service personnel.

Table 5-4: Delta Battery Cabinet Cable Diameter and Fuses

UPS (kVA)	Battery Cabinet Cable Diameter (mm ²)	Battery Fuse (A)
160	50mm ² x 2 PCS	600
200	70 mm ² x 2 PCS	600

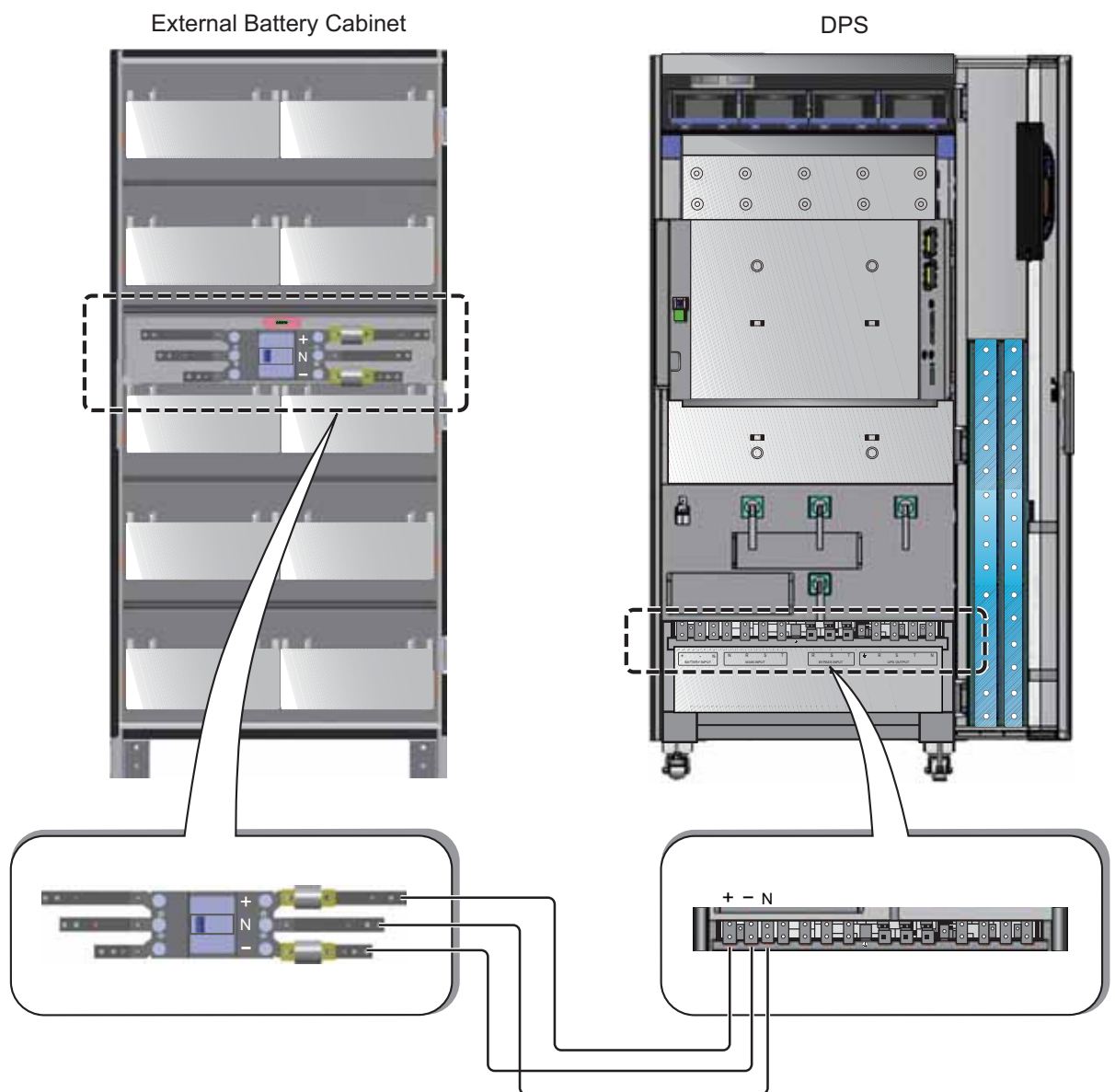

(Figure 5-p: Delta External Battery Cabinet Wiring)

To save on your costs and installation space, parallel UPSs can share Delta external battery cabinets. Please refer to **3.11 Common Battery**.

5.6.4 Delta External Battery Cabinet Alarm

When a Delta external battery cabinet (optional) connected to the UPS has the following problems, the UPS system will sound an alarm. Please see the table below.

No.	Delta External Battery Cabinet Status	Alarm
1	Battery Ground Fault	Long beep
2	Battery Cabinet Over Temp	Sounds every 0.5 second (Beep is ON for 0.25 second + Beep is OFF for 0.25 second).
3	Battery Test Fail	Sounds every 10 seconds (Beep is ON for 0.5 second + Beep is OFF for 9.5 seconds).
4	Battery Low Warning	Sounds every 0.5 second (Beep is ON for 0.25 second + Beep is OFF for 0.25 second).
5	Battery Low Shutdown	Sounds every 3 seconds (Beep is ON for 0.5 second + Beep is OFF for 2.5 seconds).
6	Battery Replacement	Sounds every 10 seconds (Beep is ON for 0.5 second + Beep is OFF for 9.5 seconds).
7	Battery Over Charge	Long beep
8	Battery Missing	Sounds every 0.5 second (Beep is ON for 0.25 second + Beep is OFF for 0.25 second).
9	Battery Breaker Off	Sounds every 0.5 second (Beep is ON for 0.25 second + Beep is OFF for 0.25 second).

NOTE

About Non-Delta External Battery Cabinet:

A non-Delta battery cabinet shall include 40 batteries (battery type: 120Ah) and you should connect the cabinet's neutral to the middle 20th and 21st batteries. If you use 38 batteries, connect the cabinet's neutral to the middle 19th and 20th batteries. If you use 42 batteries, connect the cabinet's neutral to the middle 21st and No. 22nd batteries. You should use three cables (please refer to **Table 5-3: Cable Information**) to connect a non-Delta battery cabinet with the '+', '-', and 'N' terminals marked in the Battery Input Block shown in **Figure 5-i**. When connecting a non-Delta external battery cabinet with the UPS, please install a fuse or DC breaker first. Do not use an AC breaker. Please follow the actual discharge current to decide the breaker's current capacity. A 500Vdc breaker or fuse is suggested. The closer the breaker or fuse is to the batteries, the better. Please refer to the diagram below.

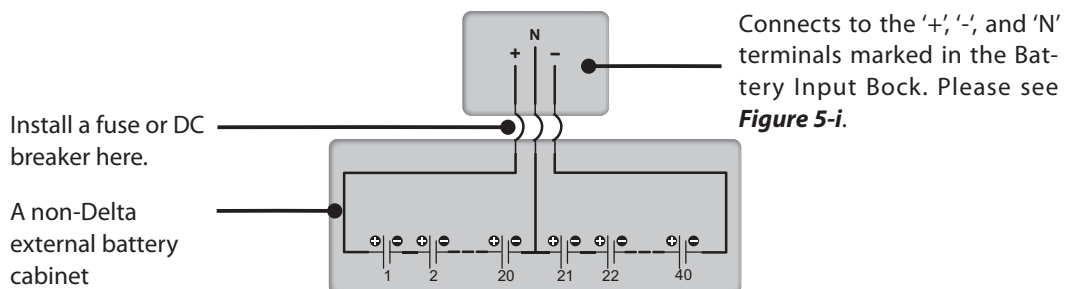

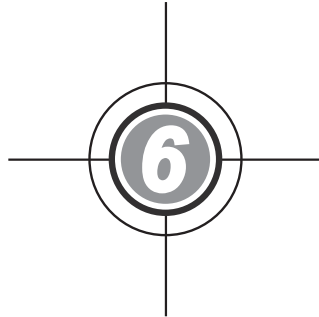

UPS Operation

6.1 Single Unit Operation
Procedures

6.2 Parallel Units Operation
Procedures



All of the unit No., date, time, and event No. (e.g. 004) shown in the LCD diagrams presented in this section are for reference only. Actual readings depend on the operation of the UPS.

6.1 Single Unit Operation Procedures

• Pre Start-up Warnings for Single Unit

1. Make sure all switches including the circuit breakers or fuses of all external battery cabinets are switched to OFF position.
2. Ensure that the voltage difference between the Neutral (N) and the Ground (⊕) is $< 3V$.
3. Check if the wiring is correct and the AC power source's voltage, frequency, phase and battery type meet UPS requirements.
4. Inspect if the fuse holders of the fan fuse and the power source fuses are closed. Please see **Figure 6-a**.

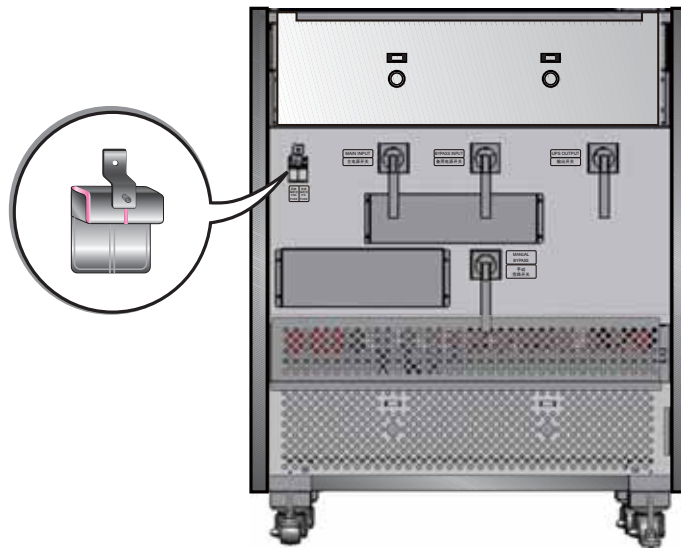



(Figure 6-a: Fuse Holders are Closed)

• Pre Turn-off Warnings for Single Unit

If you perform turn-off procedures for single unit, all power supplies will be completely cut off. Please make sure the equipment loads connected to the UPS have already been safely shutdown before you perform the turn-off procedures.

6.1.1 Normal Mode Start-up Procedures (Single)

- STEP 1:** Switch on the circuit breakers or fuses of all external battery cabinets, and ensure that the Manual Bypass Switch (Q3) is in **OFF** position.

STEP 2: Switch on the Bypass Switch (Q2). After initialization, all twelve fans start running, the Bypass AC Source LED  and the Bypass Power Supply LED  illuminate, and the following screen appears.

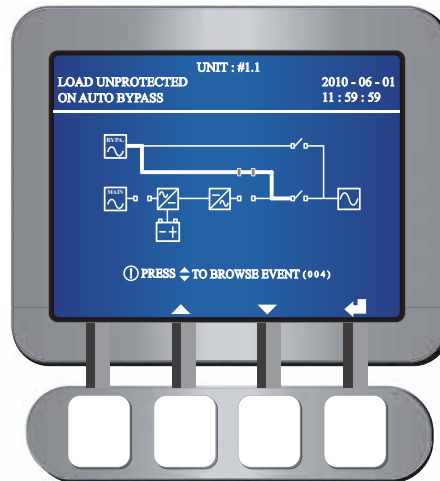

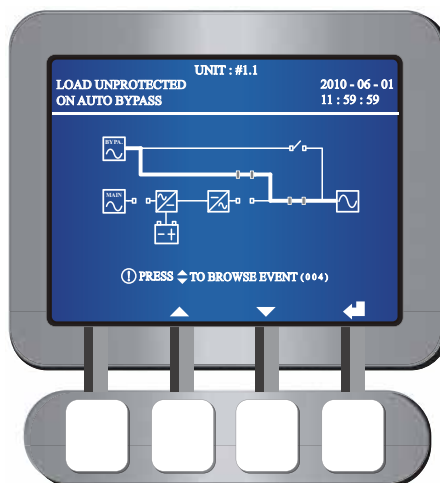

STEP 3: Turn on the UPS Output Switch (Q4), the Output Switch LED  illuminates and the following screen appears. Now the bypass supplies power to the output.



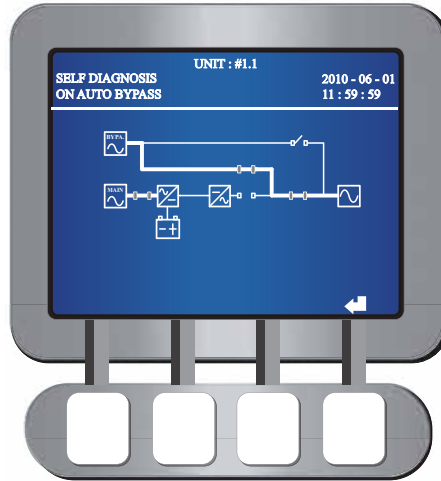

STEP 4: Switch on the Main Input Switch (Q1), the Main AC source LED  illuminates and DC BUS voltage starts establishing.

STEP 5: Press the start-up button  on the control panel for three seconds and release it after you hear one beep. The following screen appears.



STEP 6: During start-up testing period, the system starts up the inverter and the Inverter Start-up LED  lights up. The system begins synchronization with the bypass AC source.

STEP 7: After synchronization, the UPS will automatically switch from bypass mode to inverter mode, and the inverter will supply power to the output. In the meantime, the Bypass Power Supply LED  shuts off, the Inverter Power Supply LED  illuminates and the following screen appears.

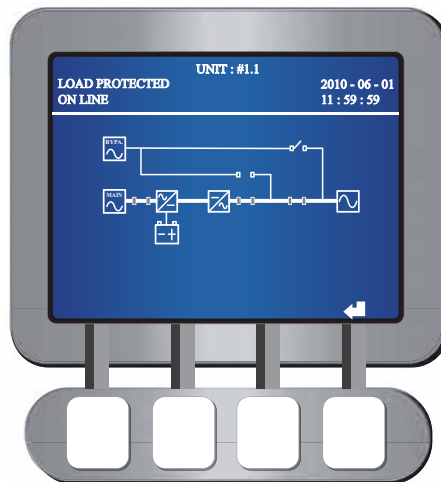

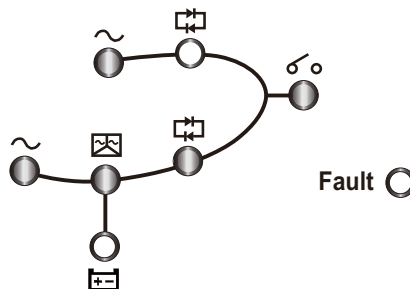

STEP 8: After you complete the normal mode start-up procedures, LEDs illuminate as follows.





6.1.2 Battery Mode Start-up Procedures (Single)

STEP 1: Switch on the circuit breakers or fuses of all external battery cabinets, ensure the Manual Bypass Switch (Q3) is in the OFF position, and turn on the UPS Output Switch (Q4).

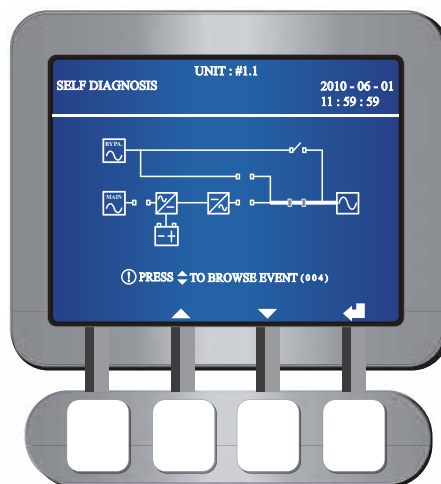
STEP 2: Press the start-up button  on the control panel for three seconds and release it after you hear one beep. The Output Switch LED  lights up and the following screen appears.



STEP 3: The UPS's power module starts running and the DC BUS voltage starts establishing. After that, the inverter will start up with default frequency. During the inverter start-up process, the Inverter Start-up LED  and the Battery Power Supply LED  illuminate.

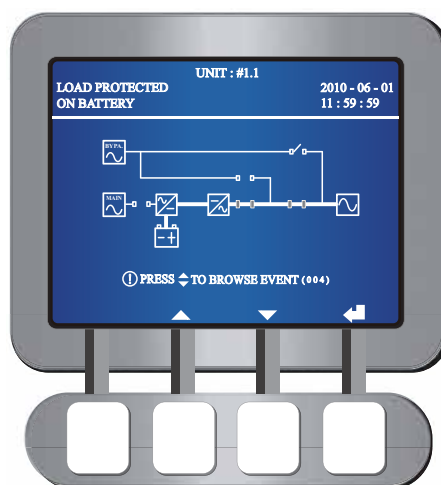

STEP 4: After the inverter starts up, the UPS will transfer to battery mode. At this moment, all twelve fans start running, the Inverter Power Supply LED  lights up and the following screen appears.



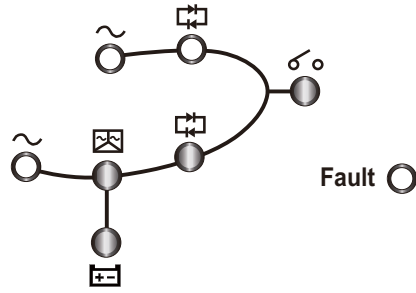

STEP 5: After you complete the battery mode start-up procedures, LEDs illuminate as follows.

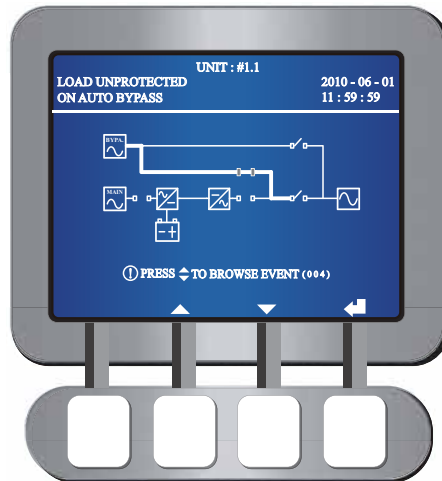

6.1.3 Bypass Mode Start-up Procedures (Single)

STEP 1: Switch on the Bypass Switch (Q2). After initialization, all twelve fans start running. The Bypass Power Source LED  and the Bypass Power Supply LED  illuminate, and the following screen appears.



STEP 2: Turn on the UPS Output Switch (Q4). The Output Switch LED  illuminates and the following screen appears. The bypass supplies power to the output.

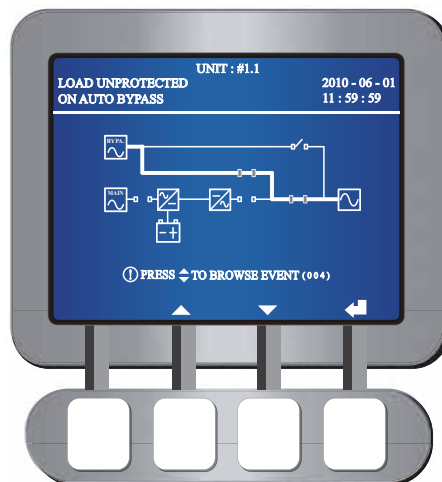

STEP 3: After you complete the bypass mode start-up procedures, LEDs illuminate as follows.

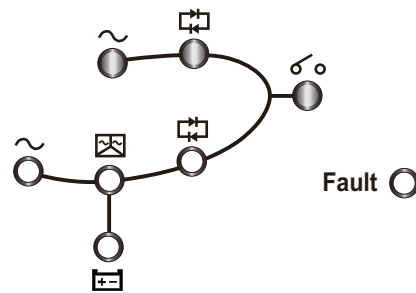

6.1.4 Manual Bypass Mode Start-up Procedures (Single Unit)





WARNING:

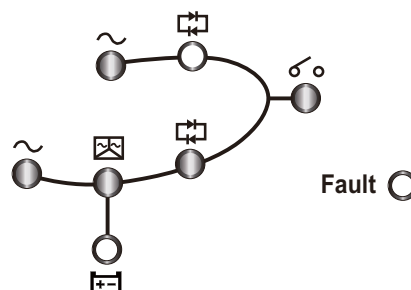

1. Please note that you can only turn on the Manual Bypass Switch (Q3) when the UPS needs maintenance. This ensures that the supply of power to the equipment loads won't discontinue. If you turn on the Manual Bypass Switch (Q3) during normal mode, the inverter will shut down, the UPS will transfer from normal mode to manual bypass mode, and the output won't be protected.
2. In manual bypass mode, the manual bypass supplies power to the equipment loads and maintenance personnel can perform maintenance without interrupting the power supply.
3. When the UPS is in manual bypass mode, there is no high voltage inside the UPS except the wiring terminal block and the Manual Bypass Switch (Q3). Do not touch the wiring terminal block and the Manual Bypass Switch (Q3) to avoid electrical shock.

• From Normal Mode to Manual Bypass Mode (Single)

1. During normal mode, LEDs illuminate as follows.



2. Press the turn-off button  on the control panel for 3 seconds and release it after you hear one beep. The LCD will show the message: 'SHUTDOWN UPS?'. Select 'YES' and press the function key below the symbol  to confirm your selection. At this

moment, the UPS transfers to bypass mode, the Inverter Start-up LED  and the Inverter Power Supply LED  shuts off, and the following screen appears.

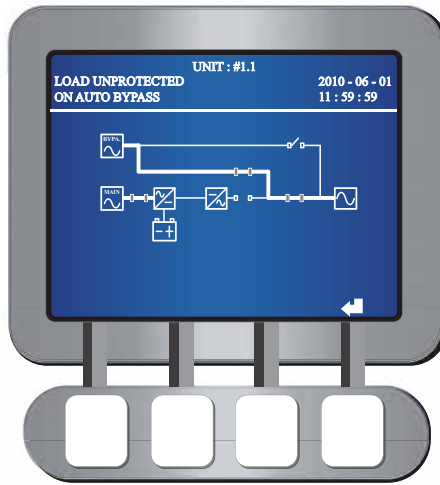

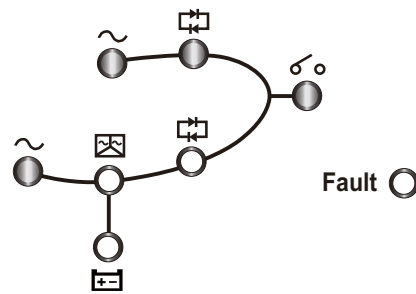

3. Check if LEDs illuminate as follows to ensure that the UPS is in bypass mode.

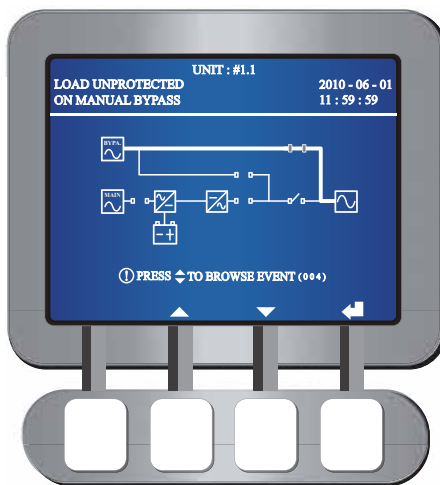

4. Turn on the Manual Bypass Switch (Q3) and turn off the Main Input Switch (Q1), the Bypass Input Switch (Q2) and the UPS Output Switch (Q4). All LEDs are off and the following screen appears.





5. Switch off the circuit breakers or fuses of all external battery cabinets.

6. When the UPS's power module performs discharging, the Inverter Start-up LED  illuminates. After the power module finishes discharging, the Inverter Start-up LED  turns off, the UPS shuts down, and no screen appears.
7. Open the fuse holders of the fan fuse and the power source fuse.

- **From Manual Bypass Mode to Normal Mode (Single)**

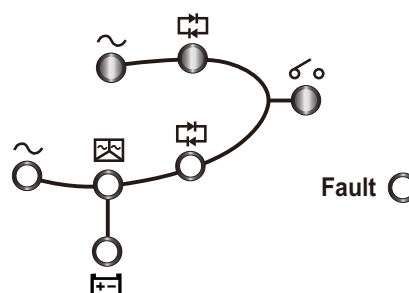
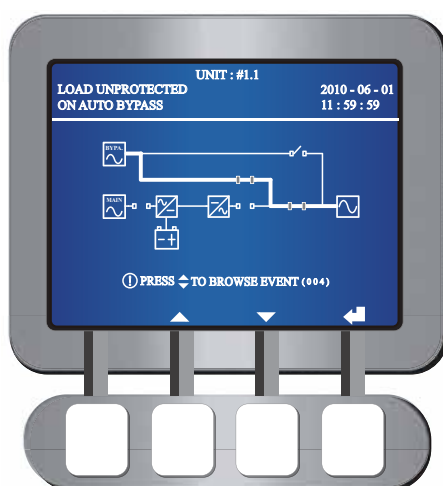
1. Close the fuse holders of the fan fuse and the power source fuse.
2. Turn on the Bypass Switch (Q2) and the UPS Output Switch (Q4). After initialization, all twelve fans start running.
3. Switch off the Manual Bypass Switch (Q3). The bypass supplies power to the equipment loads, the following screen appears and LEDs illuminate as follows.



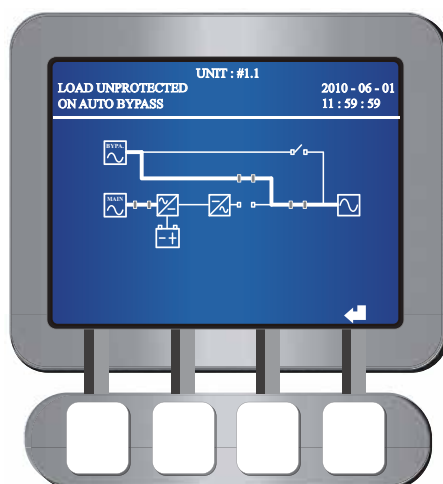

4. Switch on the circuit breakers or fuses of all external battery cabinets.
5. Turn on the Main Input Switch (Q1). The Main AC source LED  illuminates, the DC BUS voltage starts establishing, and the following screen appears.

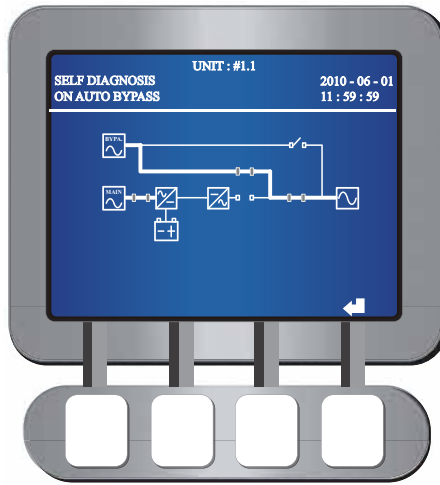

- Press the turn-on button  on the control panel for three seconds and release it after you hear one beep. The following screen appears.



- During the start-up testing period, the system starts up the inverter, the Inverter Start-up LED  lights up, and the system begins synchronization with the bypass AC source.
- After synchronization, the UPS will automatically switch from bypass mode into inverter mode, and the inverter will supply power to the output. In the meantime, the Bypass Power Supply LED  turns off, the Inverter Power Supply LED  illuminates, and the following screen appears.

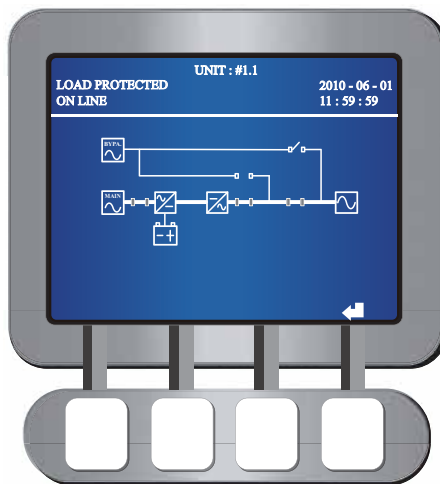

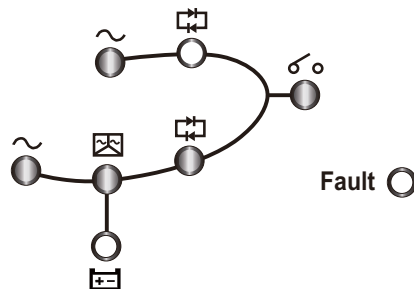

- During normal mode, LEDs illuminate as follows.

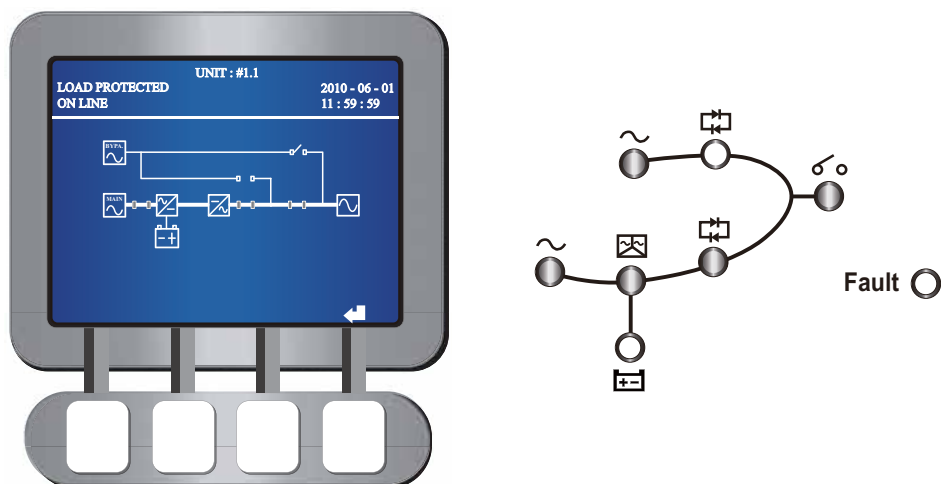

6.1.5 Normal Mode Turn-off Procedures (Single)

STEP 1: During normal mode, the following screen appears and LEDs illuminate as follows.



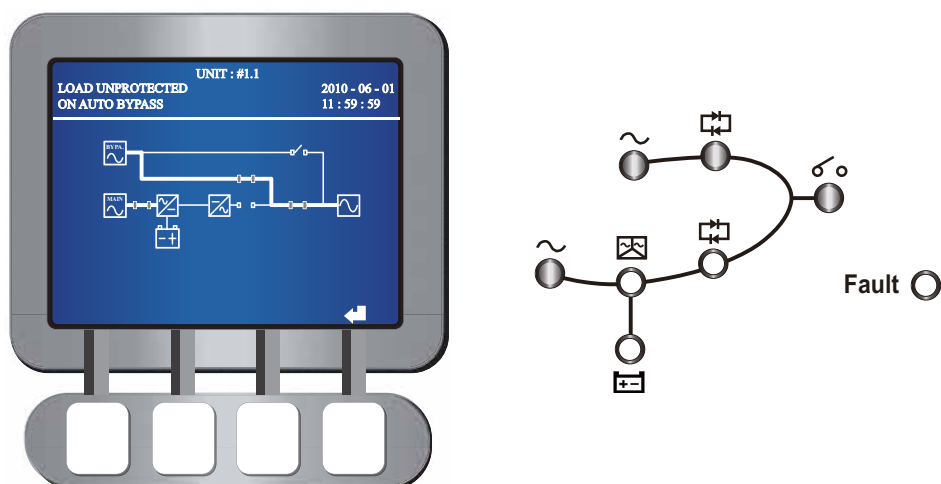

STEP 2: Press the turn-off button  on the control panel for three seconds and release it after you hear one beep. The LCD shows the message: 'SHUTDOWN UPS?'. Select 'YES' and press the function key below the symbol  to confirm your selection.

STEP 3: After you confirm your selection, the UPS transfers from normal mode into bypass mode, the following screen appears and LEDs illuminate as follows.



STEP 4: Switch off the Main Input Switch (Q1). The Main AC source LED  shuts off.



STEP 5: When the UPS's power module performs discharging, the Inverter Start-up LED  illuminates. After the power module finishes discharging, the Inverter Start-up LED  shuts off.

STEP 6: Turn off the circuit breakers or fuses of all external battery cabinets, switch off the Bypass Switch (Q2) and the UPS Output Switch (Q4). All LEDs are off and no screen appears.

6.1.6 Battery Mode Turn-off Procedures (Single)

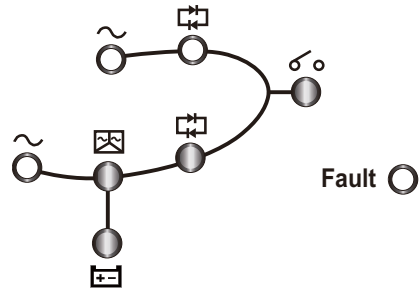
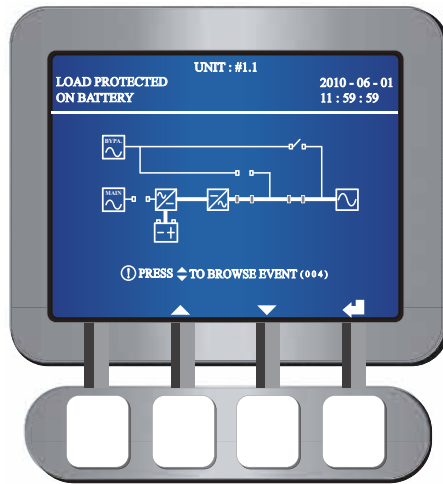

STEP 1: During battery mode, the following screen appears and LEDs illuminate as follows.

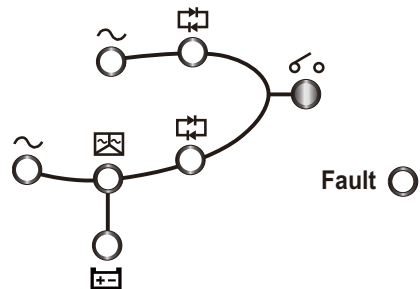
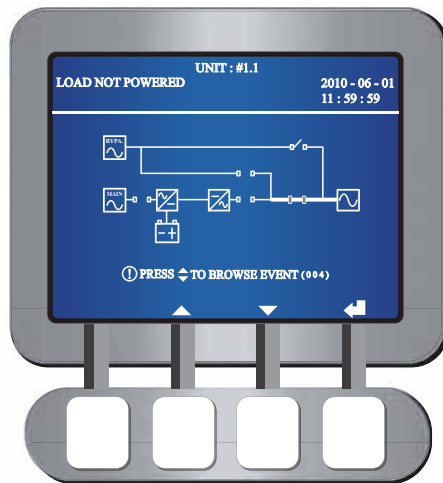

STEP 2: Press the turn-off button  on the control panel for three seconds and release it after you hear one beep. The LCD shows the message: 'SHUTDOWN UPS?'. Select 'YES' and press the function key below the symbol  to confirm your selection.

STEP 3: After you confirm your selection, the UPS turns off the inverter and cuts off the output. The following screen appears and LEDs illuminate as follows.



STEP 4: When the power module performs discharging, the Inverter Start-up LED  lights up. After the power module finishes discharging, the Inverter Start-up LED  shuts off.

STEP 5: Turn off the UPS Output Switch (Q4). All LEDs are off, and after 30 seconds, the LCD shuts down.

STEP 6: Switch off the circuit breakers or fuses of all external battery cabinets to discontinue power supply to the UPS.

6.1.7 Bypass Mode Turn-off Procedures (Single)

STEP 1: During bypass mode, the following screen appears and LEDs illuminate as follows.

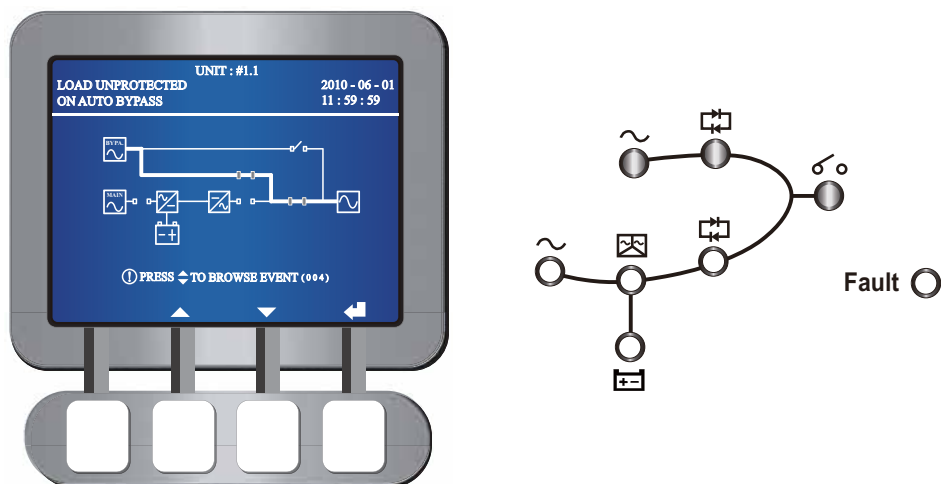

STEP 2: Turn off the Bypass Switch (Q2) and the UPS Output Switch (Q4). All LEDs are off and the LCD shuts down.

6.1.8 Manual Bypass Mode Turn-off Procedure (Single)

During manual bypass mode, no LED illuminates and no screen appears on the LCD. Just turn off the Manual Bypass Switch (Q3) to shut down the UPS.

6.2 Parallel Units Operation Procedures

- **Pre Start-up Warnings for Parallel Units**

1. Make sure all switches including the circuit breakers or fuses of all external battery cabinets are switched to the **OFF** position.
2. Ensure that the voltage difference between the Neutral (N) and the Ground (\oplus) is $< 3V$.
3. Check if the wiring is correct and the AC power source's voltage, frequency, phase and battery type meet UPS requirements.
4. Inspect if the fuse holders of the fan fuse and the power source fuse are closed.

Please see **Figure 6-b**.

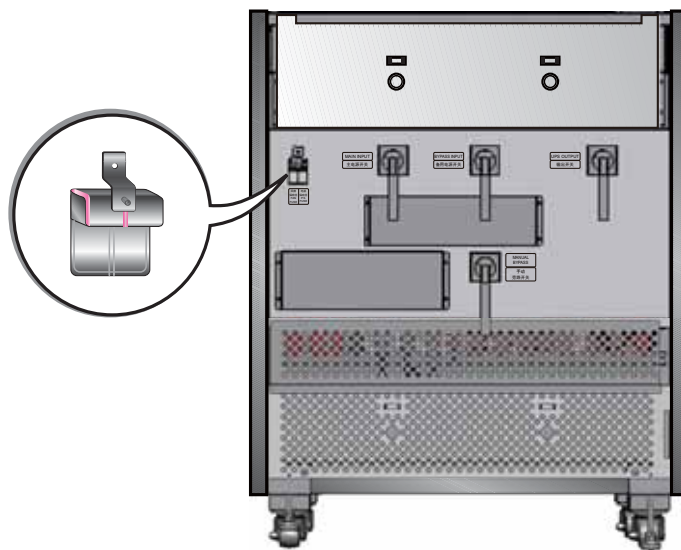

(Figure 6-b: Fuse Holders are Closed)

5. Before paralleling UPSs, please confirm that each unit's capacity, voltage and frequency are the same. After confirmation, use the provided parallel cable to connect the UPSs and make sure the parallel cable is firmly fixed.

- **Pre Turn-off Warnings for Parallel Units**

1. If you want to turn off one of the parallel UPSs, please check whether the remaining parallel UPSs' total capacity exceeds the total equipment loads. If the remaining parallel UPSs' total capacity is less than the total equipment loads, it will be the bypass that supplies power to the equipment loads. Once a power event occurs, your equipment won't be protected.
2. If you perform turn-off procedures for all parallel UPSs, all power supplies will be completely cut off. Please make sure the equipment loads connected to the parallel UPSs have already been safely shutdown before you perform the turn-off procedures.

6.2.1 Normal Mode Start-up Procedures (Parallel)



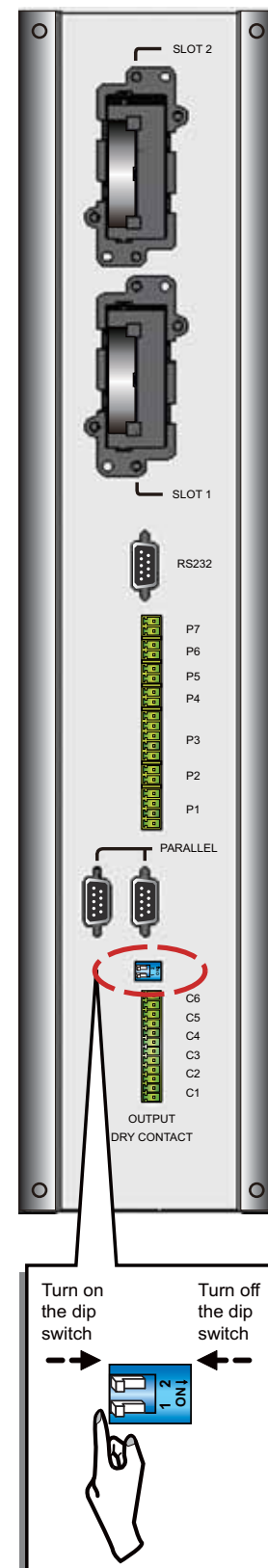

WARNING:

1. UPSs only with the same capacity, voltage and frequency can be paralleled.
2. If you want to parallel UPSs (at maximum eight), you should use the control panel to set each UPS unit No. as #1.1, #1.2, #1.3, etc. Please see **7.5.5 Parallel Setup**.
3. When paralleling UPSs, you should set up the dip switch marked in the red circle shown in the right-hand figure. To turn on the dip switch, switch the dip to the right. To turn off the dip switch, switch the dip to the left.
 - 1) When two UPSs are paralleled, turn on each UPS's dip switch.
 - 2) When three UPSs are paralleled, turn off the middle UPS's dip switch and turn on the remaining UPSs' dip switches.
 - 3) When four UPSs are paralleled, turn off the middle two UPSs' dip switches and turn on the remaining UPSs' dip switches.
 - 4) When five UPSs are paralleled, turn off the middle three UPSs' dip switches and turn on the remaining UPSs' dip switches.
 - 5) When six UPSs are paralleled, turn off the middle four UPSs' dip switches and turn on the remaining UPSs' dip switches.
 - 6) When seven UPSs are paralleled, turn off the middle five UPSs' dip switches and turn on the remaining UPSs' dip switches.
 - 7) When eight UPSs are paralleled, turn off the middle six UPSs' dip switches and turn on the remaining UPSs' dip switches.



(Figure 6-c: Set up the Dip Switch)

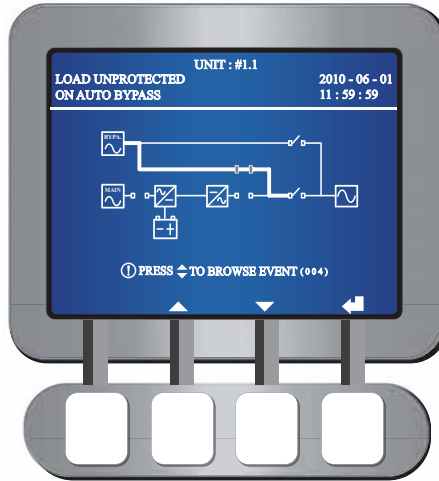

STEP 1: Turn on the circuit breakers or fuses of all external battery cabinets.

STEP 2: Switch on each UPS's Bypass Switch (Q2). After initialization, all fans (twelve per unit) start running, each unit's Bypass AC Source LED  and Bypass Power Supply LED  illuminate, and the following screen appears on each unit's LCD.

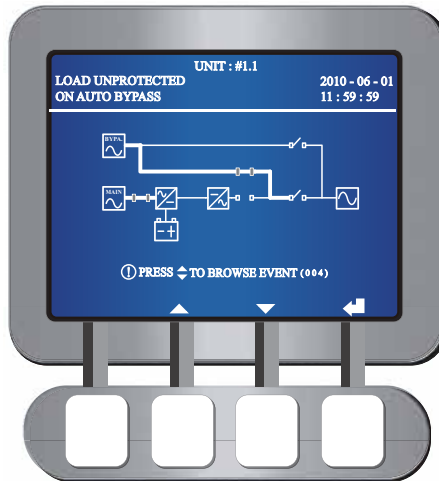

STEP 3: Turn on each UPS's Main Input Switch (Q1). Each unit's DC BUS voltage starts establishing, each unit's Main AC source LED  illuminates, and the following screen appears on each unit's LCD.



STEP 4: Press each UPS's On button  for three seconds and release it after you hear one beep. In the meantime, each unit's inverter starts up, each unit's Inverter Start-up LED  is on, each UPS is in bypass mode, and the following screen appears on each unit's LCD.

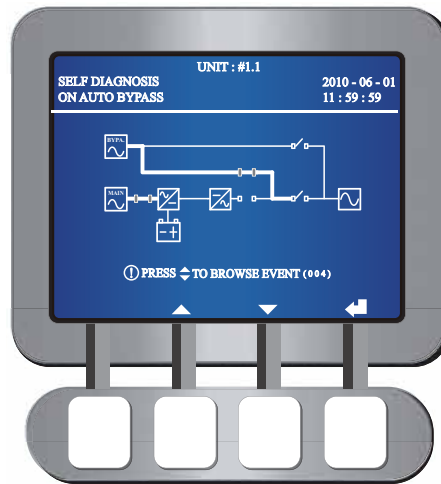

STEP 5: After each unit's inverter voltage establishes, all parallel UPS's will transfer to normal mode. At this moment, each UPS' Inverter Power Supply LED  illuminates and each UPS's LCD shows the following screen.

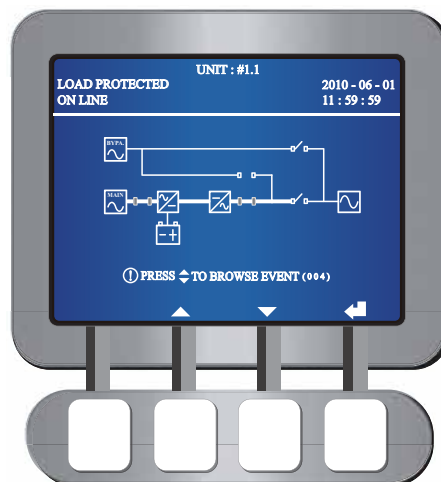

STEP 6: Measure each UPS's voltage difference between phases (should be below 5V). If normal, turn on each UPS's Output Switch (Q4). At this moment, each unit's Output Switch LED  lights on and each UPS's LCD shows the following screen. If abnormal, please contact maintenance personnel.

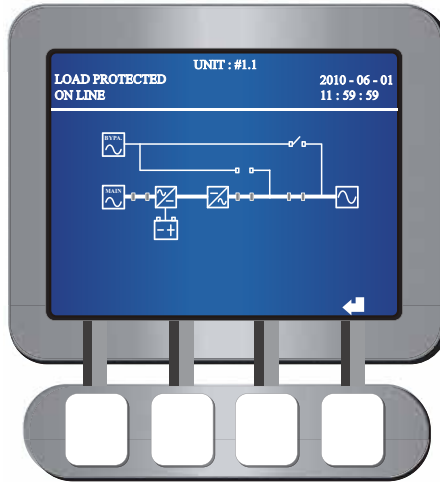

STEP 7: After you complete the normal mode start-up procedures, each UPS's LEDs illuminate as follows.

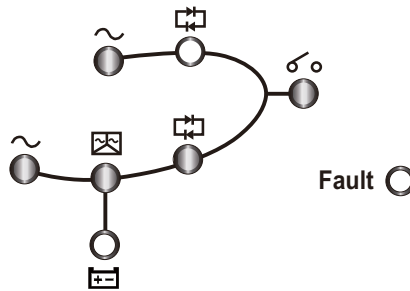



6.2.2 Battery Mode Start-up Procedures (Parallel)

STEP 1: Turn on the circuit breakers or fuses of all external battery cabinets and turn off each UPS's Manual Bypass Switch (Q3).

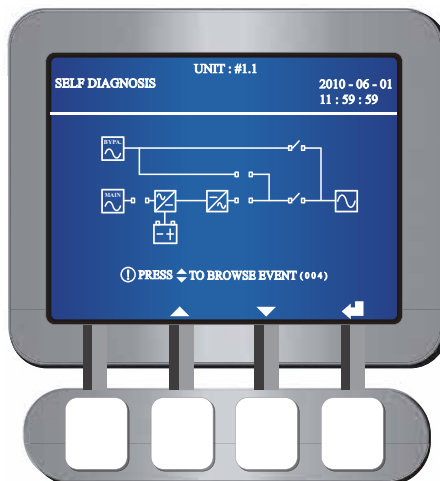
STEP 2: Press each unit's On button  on the control panel for three seconds and release it after you hear one beep. Each UPS's LCD shows the following screen.



- STEP 3:** Each unit's power module starts running, DC BUS voltage begins establishing, and inverter starts up with the default frequency. During inverter start-up process, each unit's Inverter Start-up LED  and Battery Power Supply LED  illuminate.
- STEP 4:** After each unit's inverter starts up, each UPS will transfer into battery mode. At this moment, all fans (twelve per unit) start running, each UPS's Inverter Power Supply LED  lights up and each UPS's LCD shows the following screen.

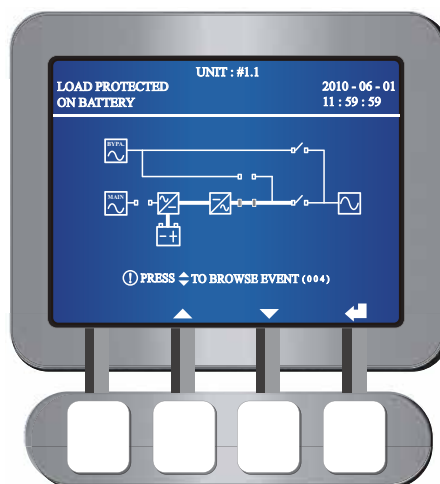

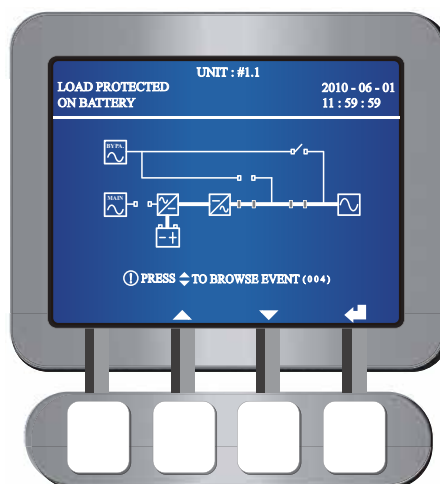

- STEP 5:** Measure each unit's voltage difference between phases (should be below 5V). If normal, turn on each unit's Output Switch (Q4). At this moment, each UPS's Output Switch LED  lights up and each UPS's LCD shows the following screen. If abnormal, please contact maintenance personnel.



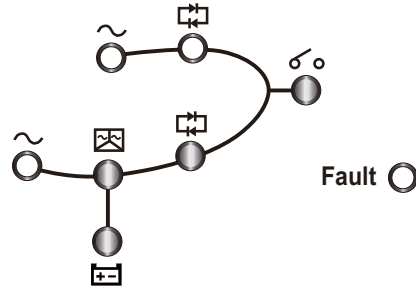

- STEP 6:** After you complete the battery mode start-up procedures, each unit's LEDs illuminate as follows.

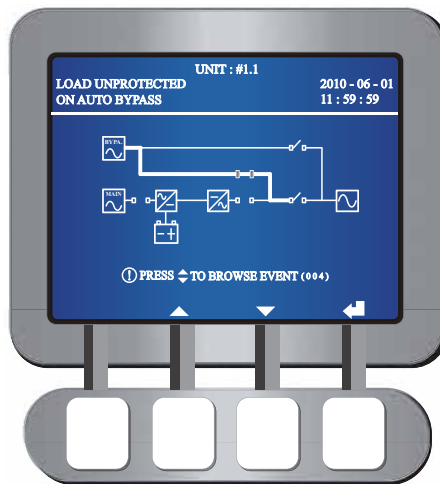

6.2.3 Bypass Mode Start-up Procedures (Parallel)

STEP 1: Switch on each UPS's Bypass Switch (Q2). After initialization, all fans (twelve per unit) start running. Each unit's Bypass AC Source LED  and Bypass Power Supply LED  illuminate, and each UPS's LCD shows the following screen.



STEP 2: Turn on each unit's UPS Output Switch (Q4). Each unit's Output Switch LED  illuminates and each unit's LCD shows the following screen. At this moment, the bypass supplies power to the output.

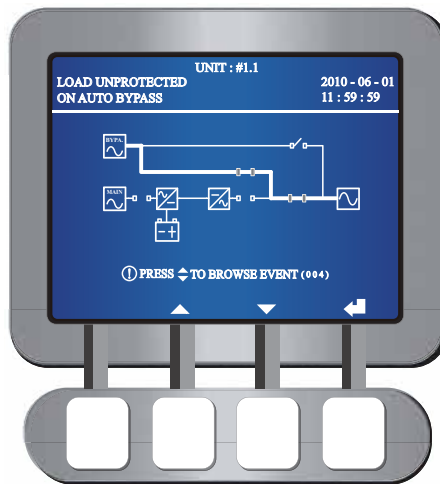

STEP 3: After you complete the bypass mode start-up procedures, each unit's LEDs illuminate as follows.

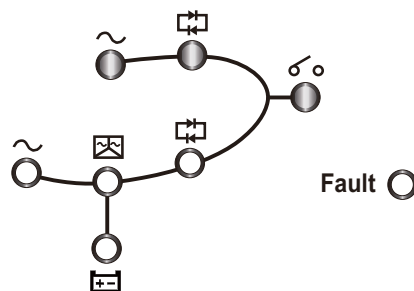



6.2.4 Manual Bypass Mode Start-up Procedures (Parallel)



WARNING:

1. Please note that you can only turn on the Manual Bypass Switch (Q3) when the UPS needs maintenance. This ensures that power supply to the equipment loads won't discontinue. If you turn on the Manual Bypass Switch (Q3) during normal mode, the inverter will shut down, the UPS will transfer from normal mode to manual bypass mode, and the output won't be protected.
2. In manual bypass mode, the manual bypass supplies power to the equipment loads and maintenance personnel can perform maintenance without interrupting the power supply.
3. When the UPS is in manual bypass mode, there is no high voltage inside the UPS except the wiring terminal block and the Manual Bypass Switch (Q3). Do not touch the wiring terminal block and the Manual Bypass Switch (Q3) to avoid electrical shock.

• From Normal Mode to Manual Bypass Mode (Parallel)

1. Press the Off button  of one of the parallel UPSs for three seconds and release it after you hear one beep. The LCD shows the message: 'SHUTDOWN UPS?'. Select 'YES' and press the function key below the symbol  to confirm your selection.
 - 1) If the remaining parallel UPSs' total capacity exceeds the total equipment loads, the inverter of the UPS that you turned off will automatically shut down, and the equipment loads will be shared equally by the remaining parallel UPSs.

The statuses of LCD and LEDs for the UPS that you turned off:

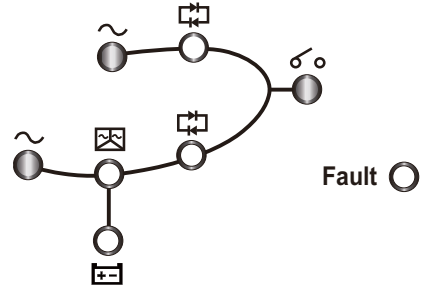
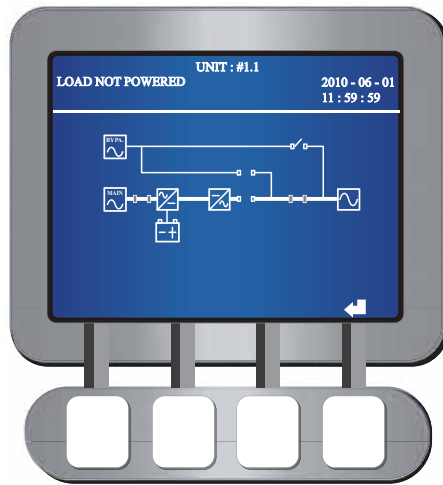

The statuses of LCD and LEDs for the the remaining parallel UPSs:

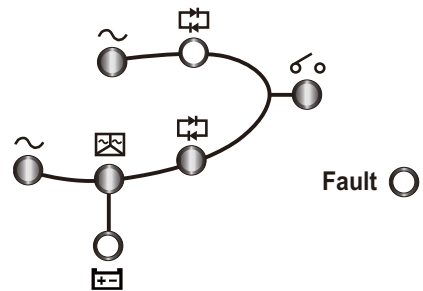
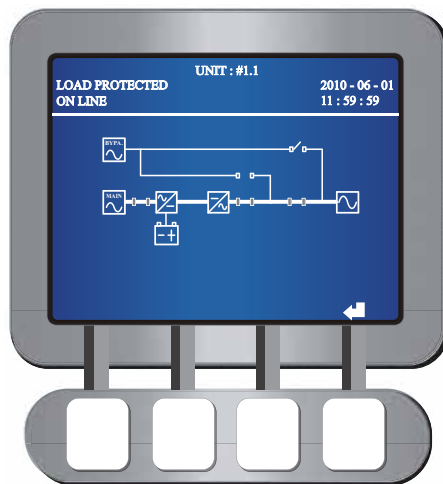

- 2) If the total equipment loads exceed the remaining parallel UPSs' total capacity, all of the parallel UPSs' inverters will shut down, inverter static switches will automatically turn off, and all parallel UPSs will transfer to bypass mode. The total equipment loads will be shared equally by all parallel UPSs, and the status of LCD and LEDs for each of the parallel UPSs is as follows.

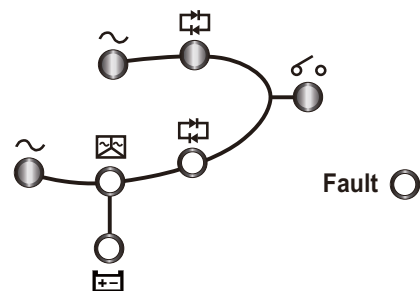
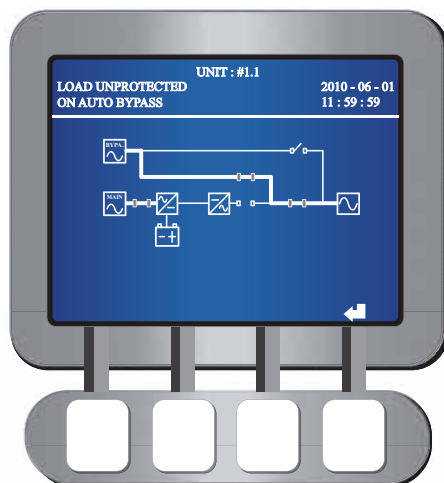

2. If the UPS that you turned off matches 1.1 situation, repeat the procedures stated in 1. to continually switch the remaining parallel UPSs into bypass mode.
3. When all parallel UPSs match 1.2 situation, turn off each UPS's Main Input Switch (Q1) and all external battery cabinets' circuit breakers or fuses. Each unit's Main AC Source LED \sim shuts off and the following screen appears.

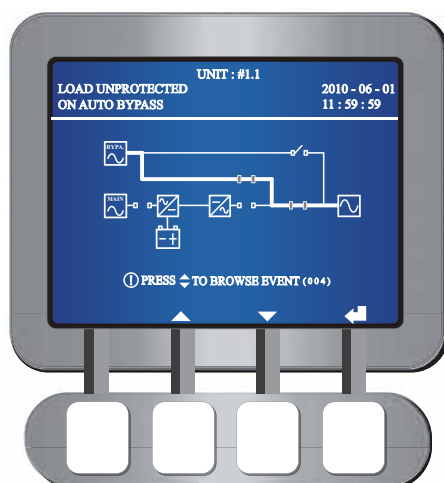

4. Each unit's power module starts discharging. During the discharging process, each UPS' Inverter Start-up LED \square illuminates. After discharging, per unit's Inverter Start-up LED \square turns off.
5. Turn on each UPS's Manual Bypass Switch (Q3). The manual bypass supplies power to the equipment loads and each UPS's LCD shows the following screen.

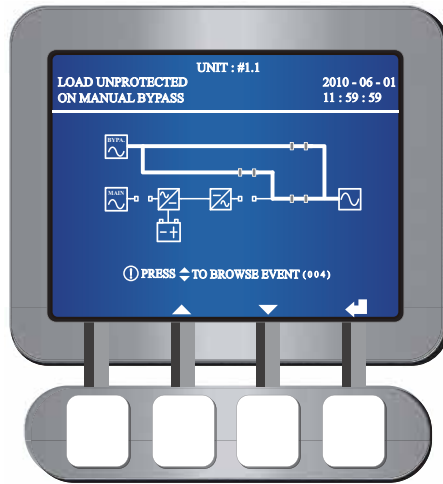

6. Turn off each unit's UPS Output Switch (Q4) and Bypass Input Switch (Q2). All fans (twelve per UPS) stop running, all LEDs are off, and each UPS's LCD shuts down.
7. Open each unit's fuse holders of the fan fuse and the power source fuse.

• **From Manual Bypass Mode to Normal Mode (Parallel)**

1. Close each UPS's fuse holders of the fan fuse and the power source fuse.
2. Turn on all external battery cabinets' circuit breakers or fuses.
3. Switch on each unit's Bypass Switch (Q2) and UPS Output Switch (Q4). After initialization, all fans (twelve per UPS) start running. Each unit's LCD shows the following screen and each UPS's LEDs illuminate as follows.

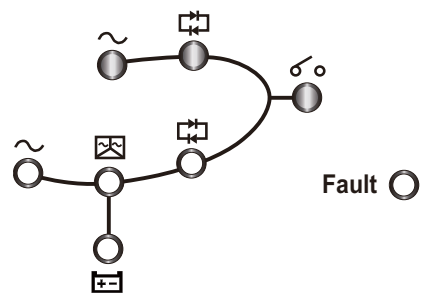
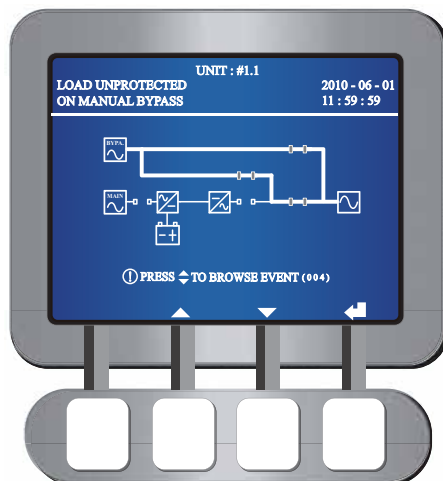

4. Turn off each UPS's Manual Bypass Switch (Q3). Per unit transfers into bypass mode, each UPS's LEDs illuminate without any change and each UPS's LCD shows the following screen.

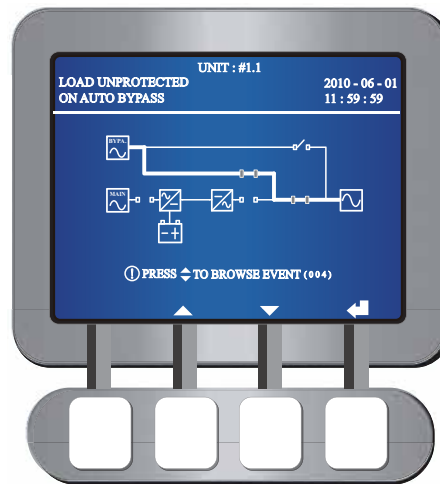

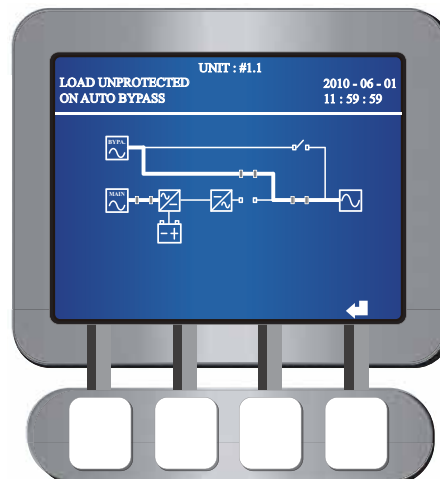

5. Switch on each UPS's Main Input Switch (Q1). Each UPS's Main AC source LED \sim illuminates and each unit's LCD shows the following screen.



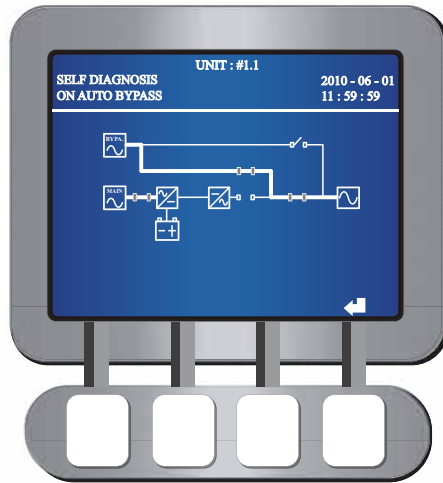

6. Press each UPS's On button  on the control panel for three seconds and release it after you hear one beep. At this moment, each UPS's LEDs illuminate without any change and each unit's LCD shows the following screen.

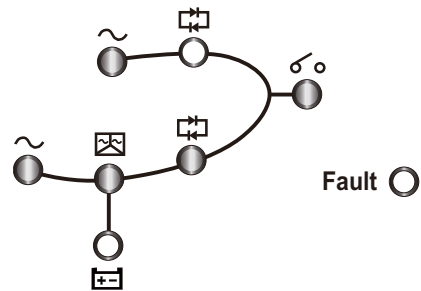
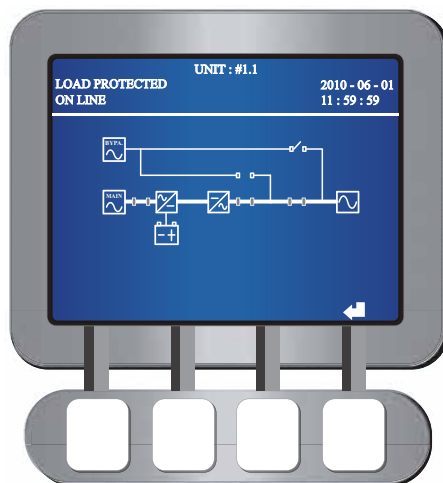

7. After each UPS's inverter voltage establishes, all parallel UPSs will convert into normal mode. At this moment, each UPS's Bypass Power Supply LED  turns off, each UPS's Inverter Start-up LED  and Inverter Power Source LED  illuminates. Each unit's LCD shows the following screen and LEDs are on as follows.



6.2.5 Normal Mode Turn-off Procedures (Parallel)

- Press the Off button  of one of the parallel UPSs for three seconds and release it after you hear one beep. The LCD shows the message: 'SHUTDOWN UPS?'. Select 'YES' and press the function key below the symbol  to confirm your selection.
 1. If the remaining parallel UPSs' total capacity exceeds the total equipment loads, the inverter of the UPS that you turned off will automatically shut down, and the equipment loads will be shared equally by the remaining parallel UPSs.

The status of the LCD and LEDs for the UPS that you turned off:

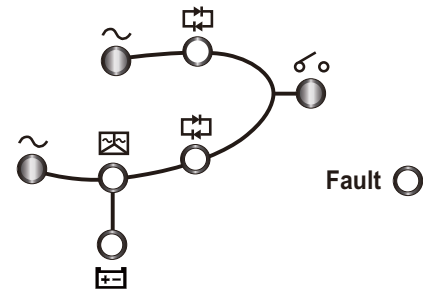
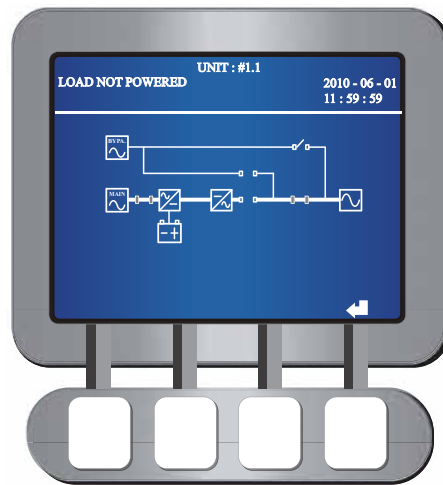

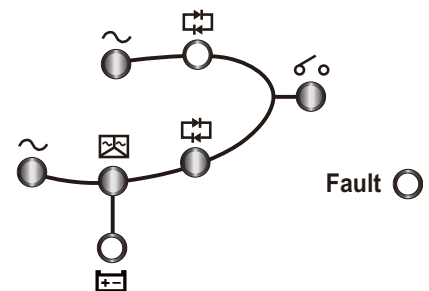
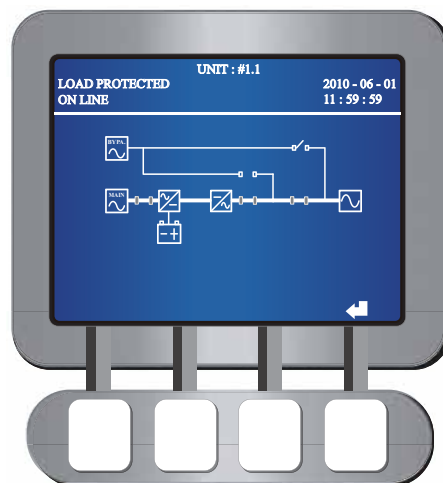

The status of the LCD and LEDs for the the remaining parallel UPSs:

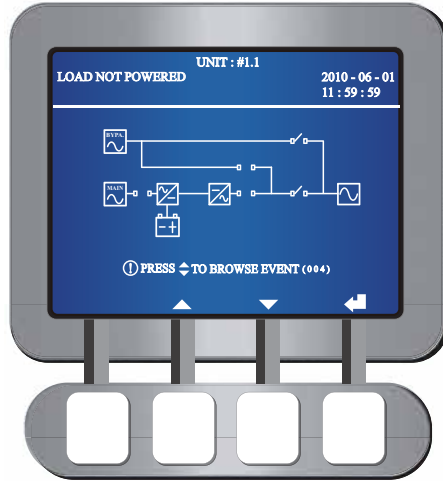

- 1) Turn off the Main Input Switch (Q1), the UPS Output Switch (Q4), and the external battery cabinets' circuit breakers or fuses of the UPS that you turned off. The Bypass AC Source LED \sim the Main AC source LED \sim and the Output Switch LED ⏏ are off, and the following screen appears.







- 2) Wait until the UPS' power module finishes discharging. During the discharging process, the Inverter Start-up LED  illuminates. After the power module finishes discharging, the Inverter Start-up LED  shuts off.
- 3) Switch off the Bypass Switch (Q2). All LEDs are off and no screen appears on the LCD.

NOTE 

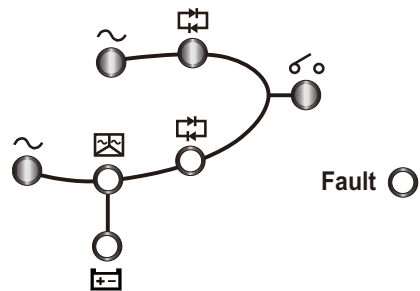
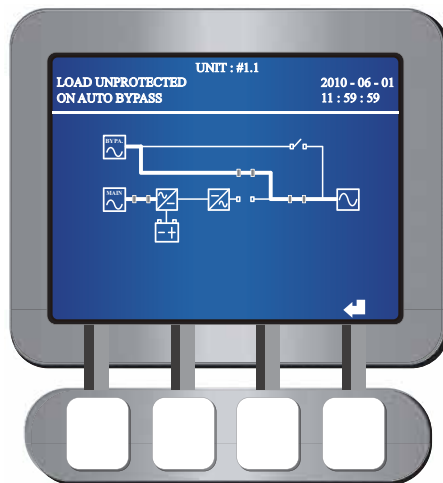

If you need to turn off the remaining parallel UPSs, please repeat the procedures above.

2. If the total equipment loads exceed the remaining parallel UPSs' total capacity, all parallel UPSs' inverters will shut down, inverter static switches will automatically turn off, and all parallel UPSs will convert to bypass mode. The total equipment loads will be shared equally by all parallel UPSs, and each of the parallel UPSs has the status of the LCD and LEDs as follows.



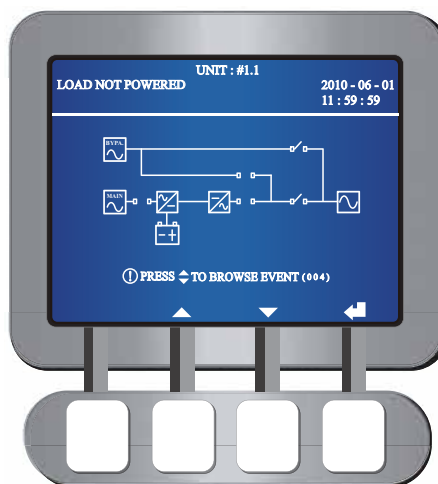

- 1) Since all parallel UPSs are in bypass mode, the equipment loads won't be protected if a power failure occurs. Please confirm whether the equipment loads should be shut down or not.
- 2) After confirmation, turn off all parallel UPSs' Main Input Switches (Q1), UPS Output Switches (Q4) and external battery cabinet's circuit breakers or fuses. All Bypass AC Source LEDs  illuminate, all Main AC source LEDs  and all Output Switch LEDs  are off, and the following screen appears on each of the parallel UPSs' LCDs.



- 3) Wait until all parallel UPSs' power modules finish discharging. During the discharging process, each UPS's Inverter Start-up LED  illuminates. After the power modules finish discharging, each UPS's Inverter Start-up LED  is off.
- 4) Switch off each UPS's Bypass Switch (Q2). Each unit's LCD and LEDs are off.

6.2.6 Battery Mode Turn-off Procedures (Parallel)

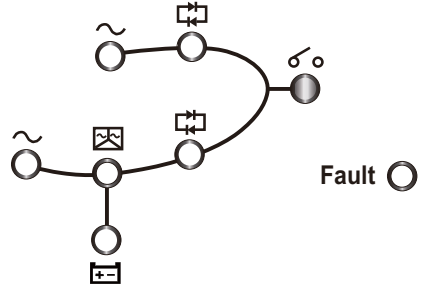
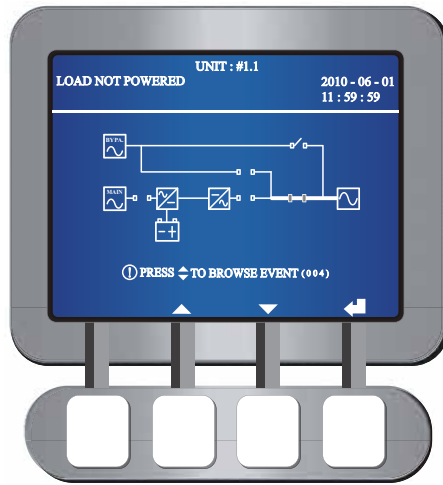

- Press the Off button  of one of the parallel UPSs for three seconds and release it after you hear one beep. The LCD shows the message: 'SHUTDOWN UPS?'. Select 'YES' and press the function key below the symbol  to confirm your selection.
 1. If the remaining parallel UPSs' total capacity exceeds the total equipment loads, the inverter of the UPS that you turned off will automatically shut down, and the equipment loads will be equally shared by the remaining parallel UPSs.

The status of the LCD and LEDs for the UPS that you turned off:



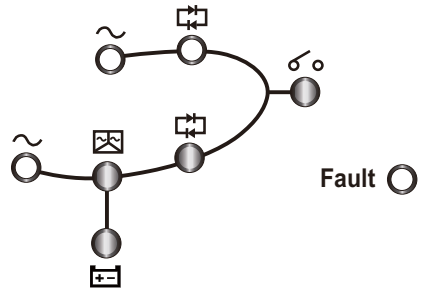
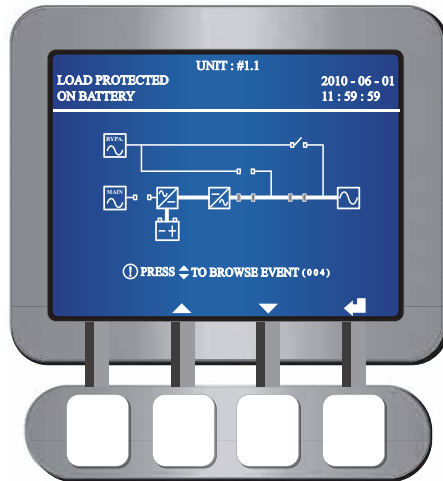

The status of the LCD and LEDs for the the remaining parallel UPSs:

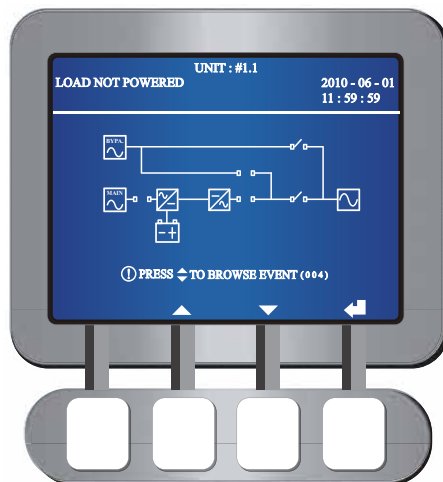

- 1) Switch off the UPS Output Switch (Q4) of the UPS that you turned off. The Output Switch LED   shuts off and the following screen appears.





- 2) Wait until the UPS's power module finishes discharging. During the discharging process, the Inverter Start-up LED  illuminates. After the power module finishes discharging, the Inverter Start-up LED  is off.
- 3) After 30 seconds, all LEDs and LCD are off.

NOTE

If you need to turn off the remaining parallel UPSs, please repeat the procedures above.

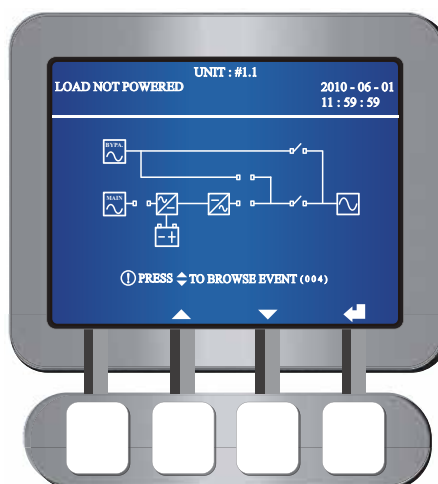
2. If the total equipment loads exceed the remaining parallel UPSs' total capacity, all parallel UPSs' inverters will shut down and inverter static switches will automatically turn off. At this moment, no power supplies to the equipment loads.
 - 1) Turn off each unit's Output Switches (Q4). Each Output Switch LED  shuts off and the following screen appears on each UPS's LCD.



- 2) Wait until all parallel UPSs' power modules finish discharging. During the discharging process, each Inverter Start-up LED  illuminates. After the power modules finish discharging, each Inverter Start-up LED  is off.
- 3) After 30 seconds, all parallel UPSs' LEDs and LCDs shut off.

6.2.7 Bypass Mode Turn-off Procedures (Parallel)

STEP 1: During bypass mode, the status of the LCD and LEDs for each of the parallel UPSs are as follows.

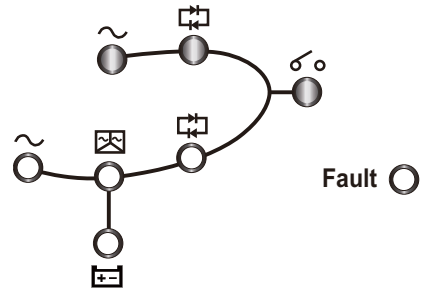
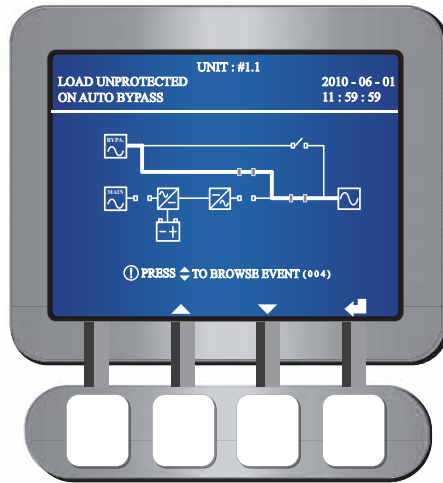

STEP 2: Turn off one of the parallel UPSs' Bypass Switch (Q2) and UPS Output Switch (Q4). The UPS' LEDs and the LCD are off. If you need to turn off the remaining parallel UPSs, please repeat the procedures above.

6.2.8 Manual Bypass Mode Turn-off Procedure (Parallel)

During manual bypass mode, no LED illuminates and no screen appears. Turn off each UPS's Manual Bypass Switch (Q3) to shut down the parallel UPSs.

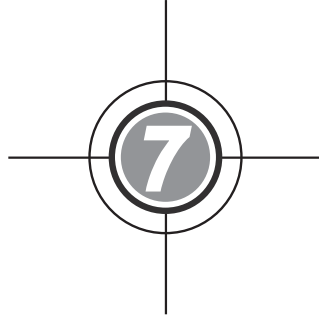

LCD Display and Settings

7.1 LCD Display & Function Keys

7.2 Main Screen

7.3 Main Menu

7.4 Measure

7.5 UPS Setup & Control

7.6 Maintenance

NOTE 

All unit No., UPS status, date, time, and event No. (e.g. 004) shown in the LCD diagrams presented in this section are for reference only. Actual readings depend on the operation of the UPS.

7.1 LCD Display & Function Keys

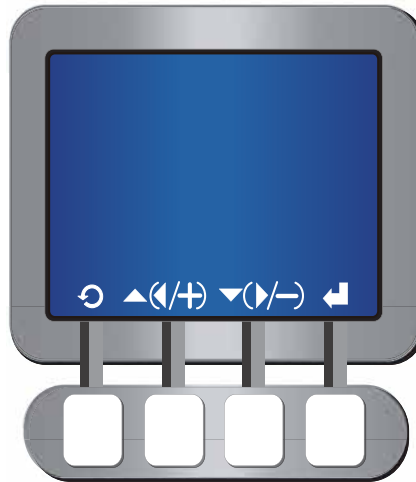









(Figure 7-a: LCD Display)

On the front of the UPS, there is an LCD display that lets you check the status of the UPS. The language default setting is English. If you want to change the default setting, please refer to **7.5 UPS Setup & Control** and **7.5.7 Local Setup**. There is no symbol on the function keys. The functions of keys depend on the symbols appearing on the LCD display. Please see the symbol table below.

NOTE 

The language default setting may be different according to countries.



No.	Symbol	Function
1		Goes back to previous screen or cancels current selection.
2		Moves up
3		Moves down
4		Moves left
5		Moves right
6		Increases number
7		Decreases number
8		Confirms selection

7.2 Main Screen

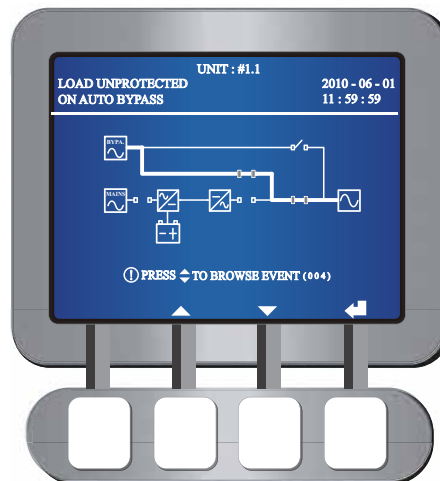



When you turn on the Bypass Switch (Q2) and the UPS Output Switch (Q4), the UPS starts up and the following screen appears. The system shows different screens depending on the status of the UPS. There are nine statuses, and each is called **Main Screen**.

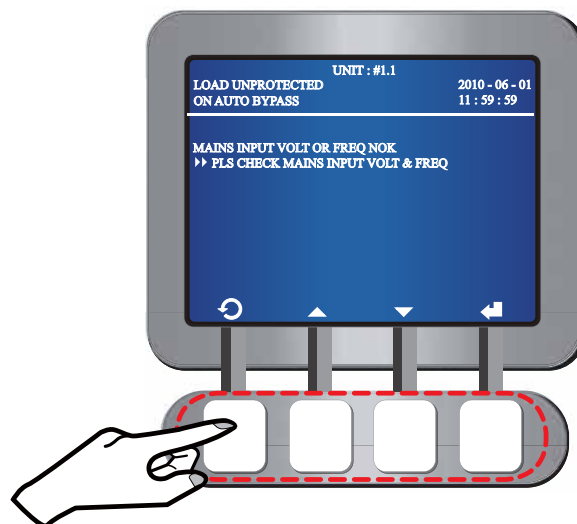

WARNING:

1. When an alarm occurs, you will see the sign  flash. Please press the function key below the symbol  to view an alarm message. Please see the screen below for an example.



2. Press the function key below the symbol  to read the next warning message. Use the function keys below the symbols  and  to switch between warning messages.
3. Press the function key below the symbol  to go back to the main screen.
4. If a screen is idle for 5 minutes, backlight shuts off and the screen goes back to the main screen. Press any function key to resume the backlight.

The nine statuses of the UPS shown in the LCD display are as follows.

①

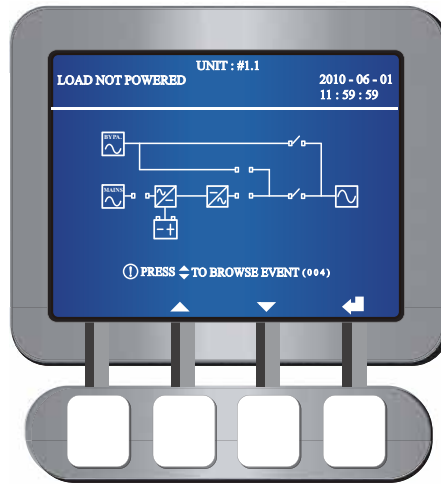

When the screen above appears, it means that no power is supplied to the equipment loads connected.

②

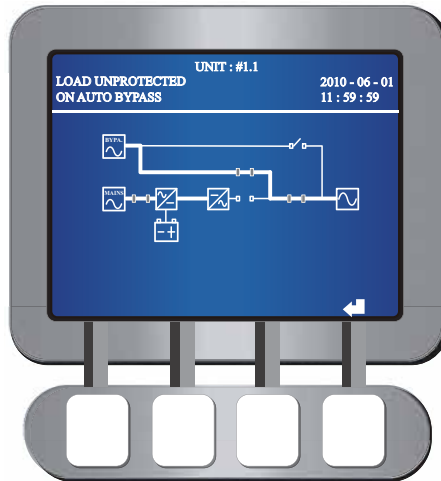

When the screen above appears, it means the bypass is supplying power to the equipment loads.

③

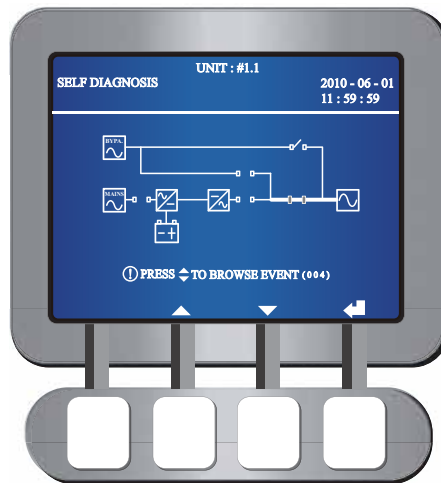

When the screen above appears, it means that batteries have started up the UPS.

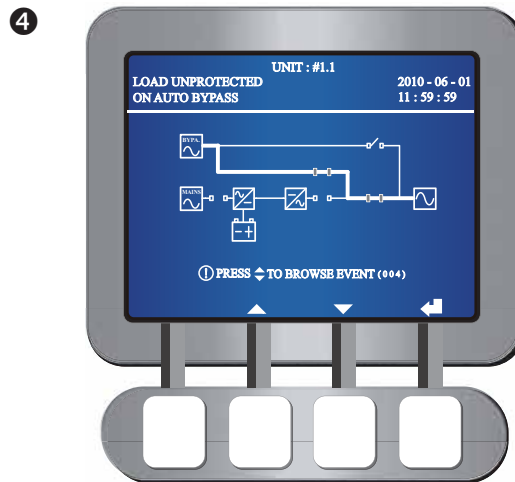

When the screen above appears, it means that the UPS is in bypass mode. The main AC source and the batteries are off. If the bypass AC source fails, the equipment loads won't be protected.

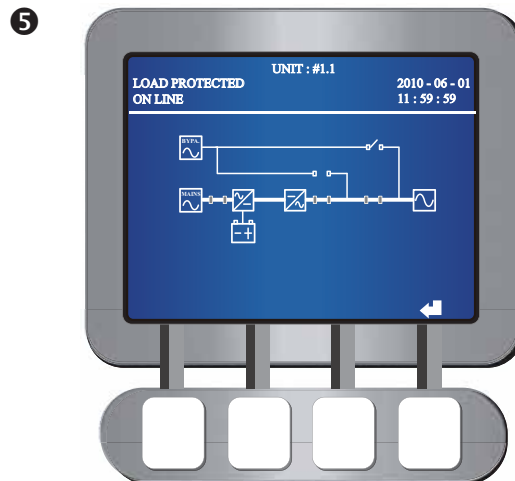

When the screen above appears, it means that the UPS is in normal mode.

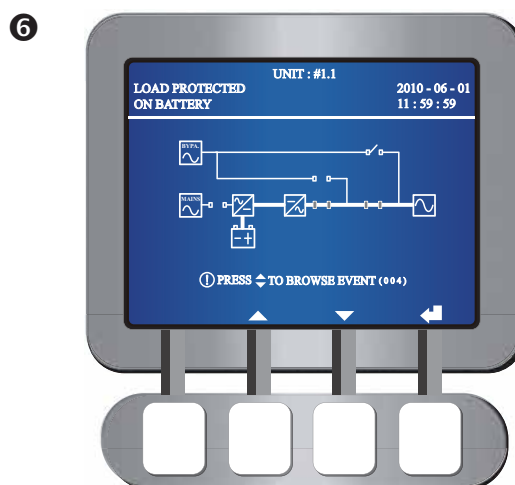

When the screen above appears, it means that the UPS is in battery mode.

7

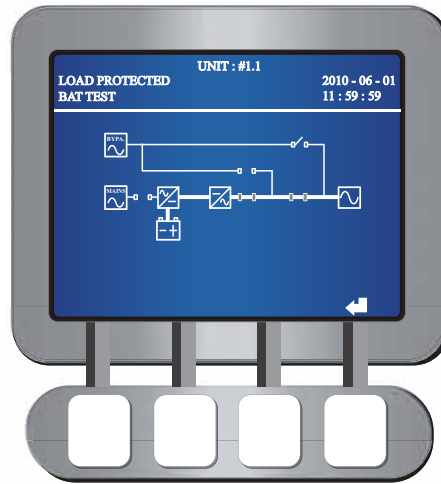

When the screen above appears, it means that the UPS is executing a battery test.

8

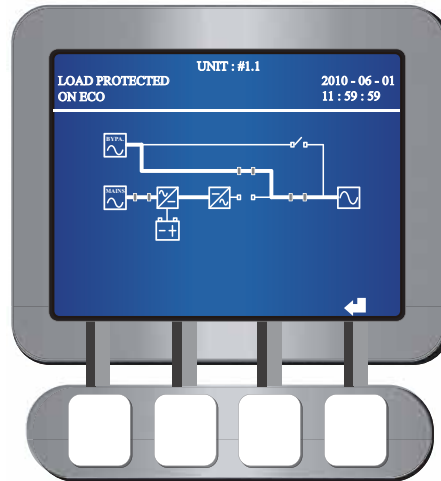

When the screen above appears, it means that the UPS is in ECO mode and the bypass supplies power to the equipment loads. Please see **7.5.2 Output Setup** for ECO mode setup.

NOTE

To ensure power supply quality, it is recommended that you set up the UPS in ECO mode only when the line power is stable. Only maintenance personnel can set up ECO mode. Please see **7.5 UPS Setup & Control**.

9

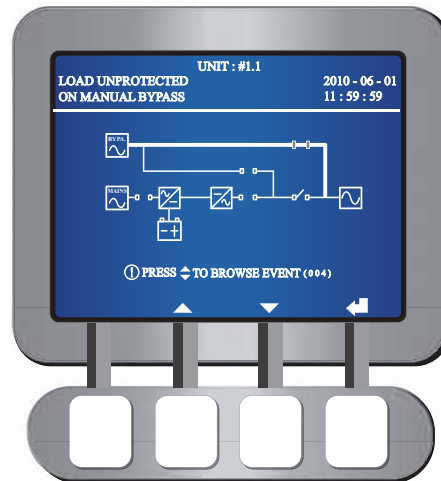

When the screen above appears, it means that the UPS is in manual bypass mode. Before maintenance, do not forget to switch the UPS into manual bypass mode and cut off the main AC source and batteries. During this mode, if the bypass AC source fails, the equipments loads won't be protected.

7.3 Main Menu

To enter into **Main Menu** shown below, press the function key below the symbol ◀ in a **Main Screen**.

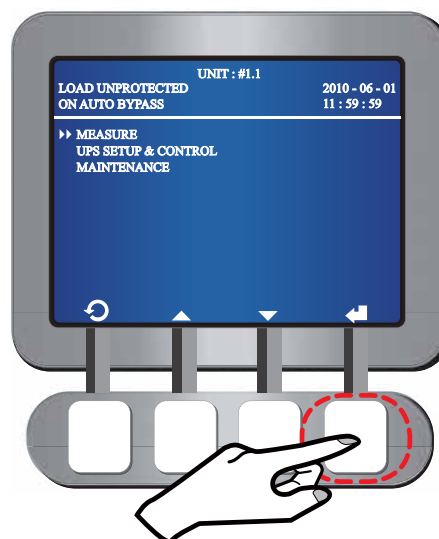

7.3.1 LCD Display Hierarchy

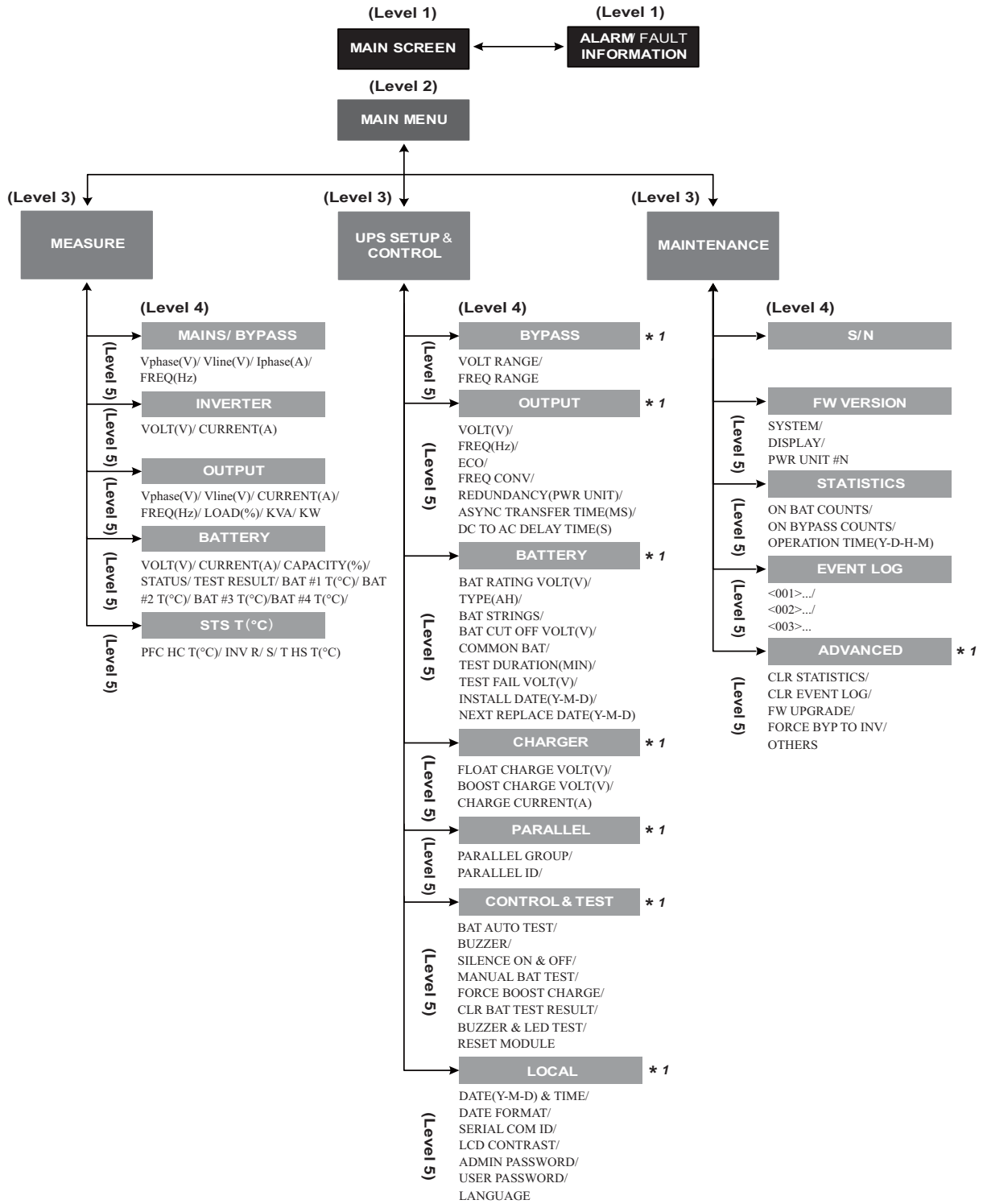

(Figure 7-b: LCD Display Hierarchy)



***1** means that password confirmation is necessary. Please see **7.5 UPS Setup & Control** and **7.6.4 Advanced Setup**.

7.4 Measure

In the **Main Menu** shown below, use the function keys below the symbols ▲ and ▼ to select **MEASURE**, and press the function key below the symbol ◀ to enter the **MEASURE** screen.

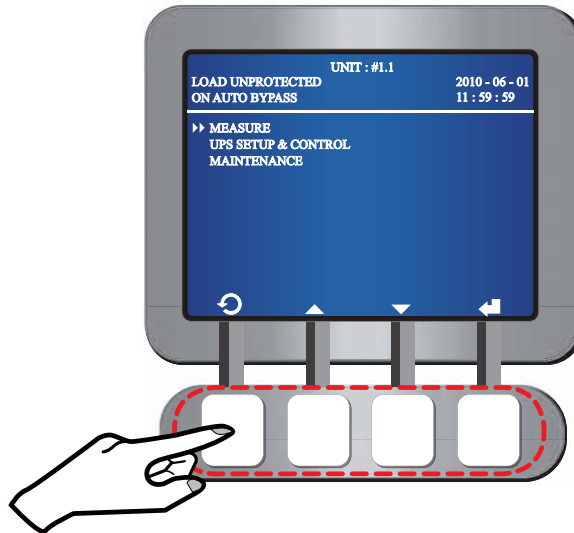

After entering the **MEASURE** screen, use the function keys below the symbols ▲ and ▼ to view the UPS status and parameters as follows.

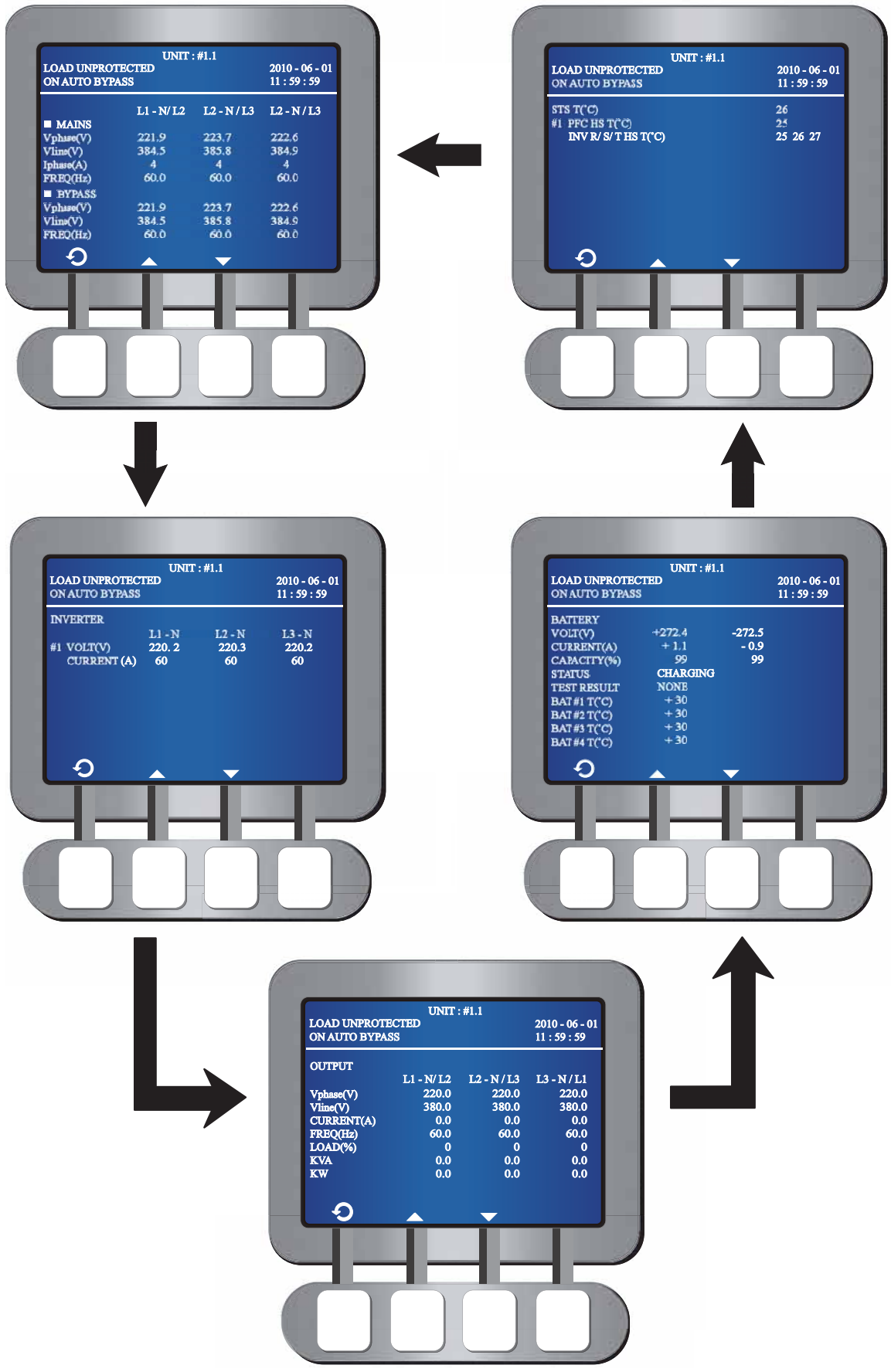

Press the function key below the symbol  to go back to the **MEASURE** screen.

7.5 UPS Setup & Control

In the **Main Menu**, use the function keys below the symbols ▲ and ▼ to select 'UPS SETUP & CONTROL', and press the function key below the symbol ◀ to enter the **UPS SETUP & CONTROL** screen. Please see the following LCD diagrams.

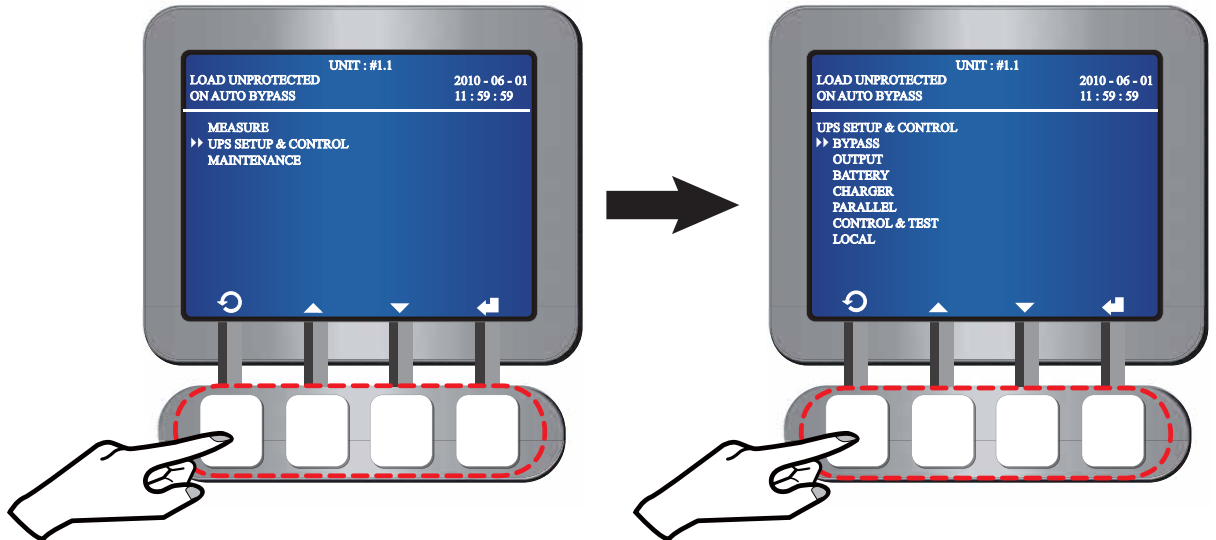

WARNING:

If you want to change any setup under the hierarchy of **UPS SETUP & CONTROL**, you must login and enter your password first. If an interval between settings is over 5 minutes, you have to login and enter the password again. Please see the description below.

1. Use the function keys below the symbols ▲ and ▼ to select an item that you want to change setting. Press the function key below the symbol ◀, and the following screen appears.

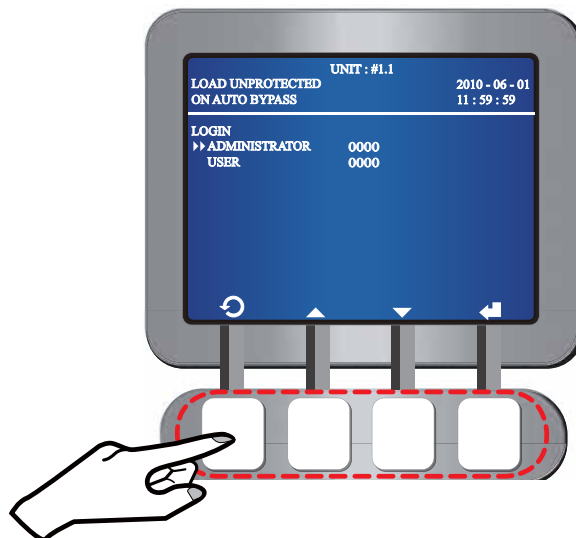

2. In the **LOGIN** screen shown above, use the function keys below the symbols ▲ and ▼ to select **ADMINISTRATOR** or **USER** as a log-in ID and use the function key below the symbol ◀ to confirm your selection. After confirmation, the following screen appears.

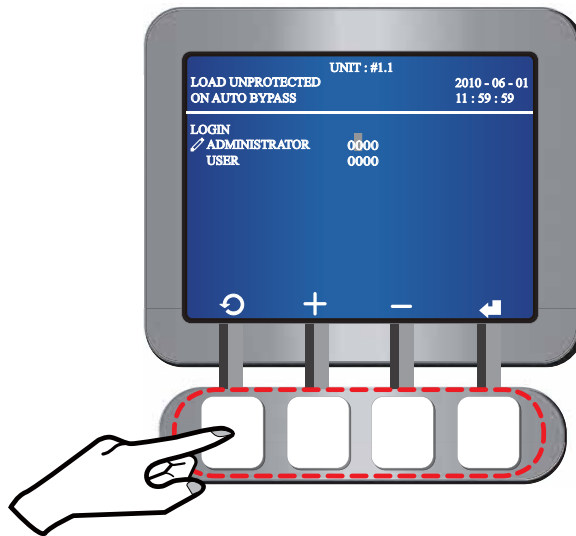

3. **ADMINISTRATOR** means qualified installation and maintenance personnel, and **USER** means general users. Users can only set up (1) **DATE & TIME**, (2) **DATE FORMAT**, (3) **LCD CONTRAST**, (4) **USER PASSWORD** and (5) **LANGUAGE**. Please refer to **7.5.7 Local Setup**. As for other setup, only qualified installation and maintenance personnel have authority to make changes.
4. Either **ADMINISTRATOR PASSWORD** or **USER PASSWORD** includes four digits. Use the function keys below the symbols **+** and **-** to enter the first digit and use the function key below the symbol **←** to confirm your selection. Repeat this procedure to complete key-in of password. Please refer to the figure below.

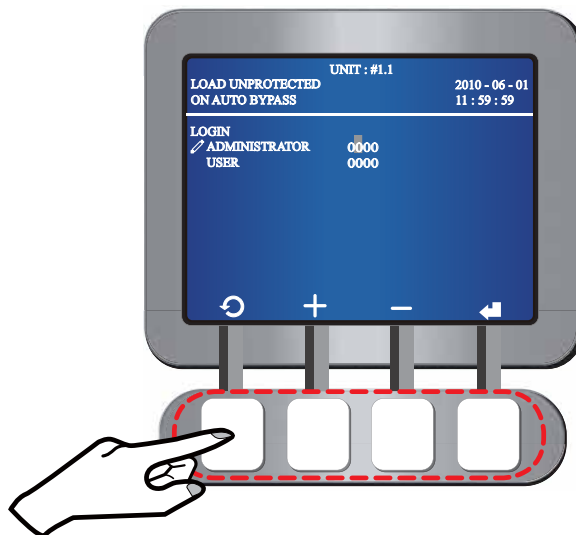

5. If the password is wrong, the system will go back to the screen that you have selected the item for setup change. Please repeat the procedures above to login and enter password again.

7.5.1 Bypass Setup

In the **UPS SETUP & CONTROL** screen, use the function keys below the symbols ▲ and ▼ to select **BYPASS** and press the function key below the symbol ◀ to enter the **BYPASS SETUP** screen. Please see the following LCD diagrams.

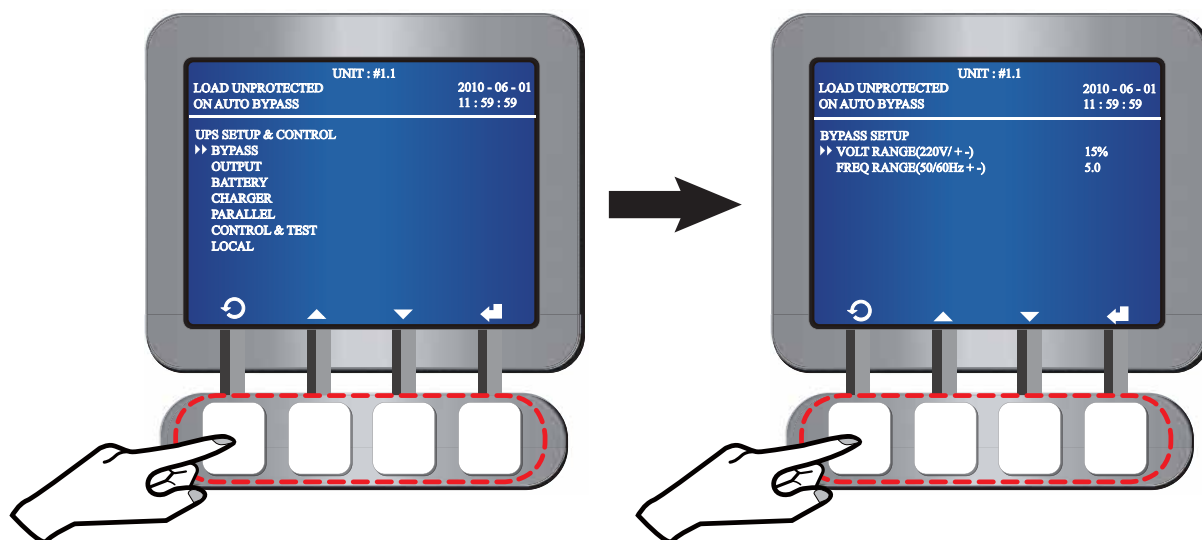

- **Voltage Range**

1. In the **BYPASS SETUP** screen, use the function keys below the symbols ▲ and ▼ to select **VOLT RANGE** and use the function key below the symbol ◀ to confirm your selection.
2. When the symbol ▶▶ changes to the symbol ✎, use the function keys below the symbols + and - to set up the voltage range, and use the function key below the symbol ◀ to confirm your setup.

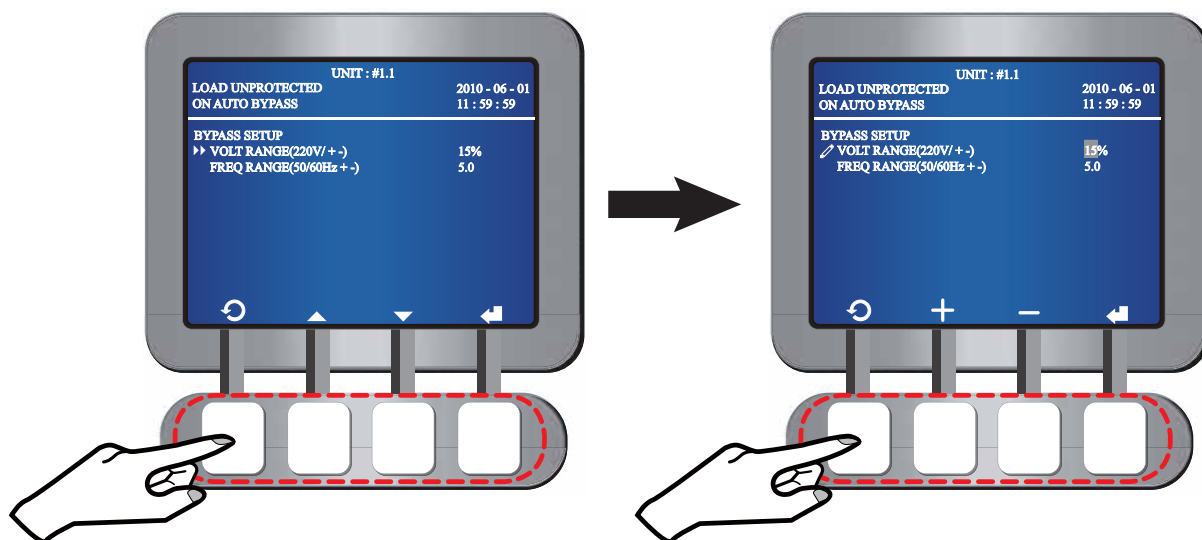

- **Frequency Range**

1. In the **BYPASS SETUP** screen, use the function keys below the symbols ▲ and ▼ to select **FREQ RANGE** and use the function key below the symbol ◀ to confirm

your selection.

- When the symbol changes to the symbol , use the function keys below the symbols **+** and **-** to set up the frequency range, and use the function key below the symbol to confirm your setup.

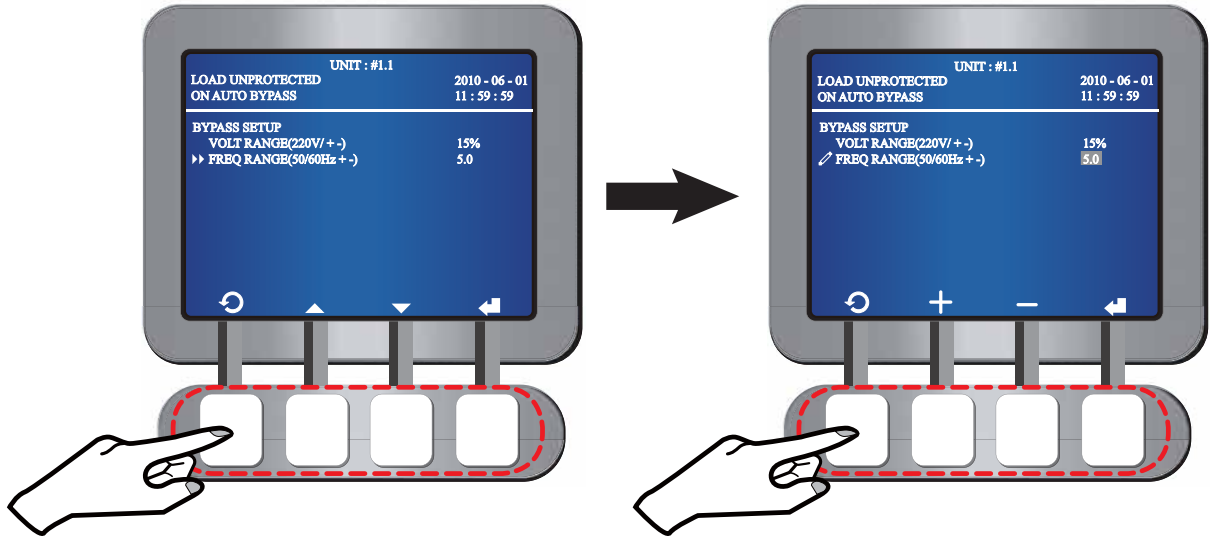

Press the function key below the symbol to go back to the **UPS SETUP & CONTROL** screen.





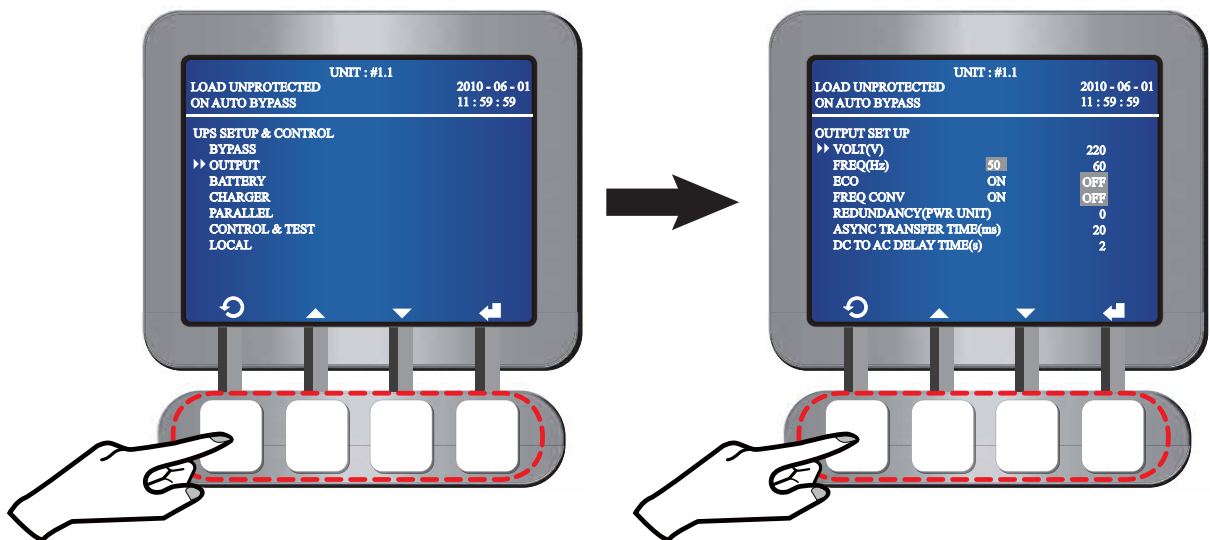

7.5.2 Output Setup

In the **UPS SETUP & CONTROL** screen, use the function keys below the symbols and to select **OUTPUT** and press the function key below the symbol to enter the **OUTPUT SETUP** screen. Please see the following LCD diagrams.



- **Voltage**





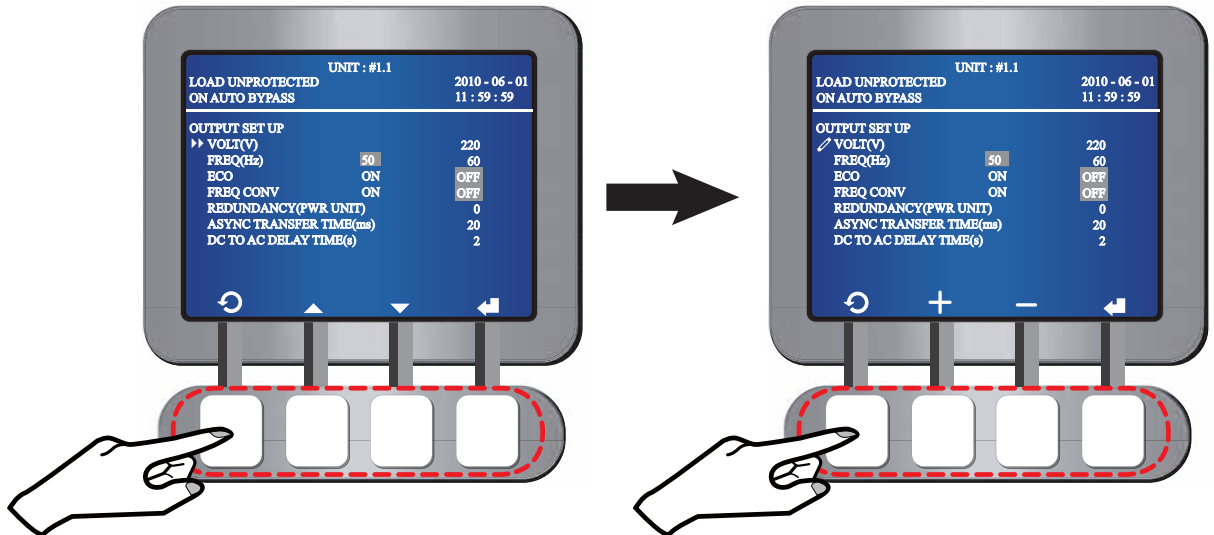



- In the **OUTPUT SETUP** screen, use the function keys below the symbols and

- to select **VOLT (V)** and use the function key below the symbol  to confirm your selection.
- When the symbol  changes to the symbol , use the function keys below the symbols  and  to set up output voltage, and use the function key below the symbol  to confirm your setup.



The voltage range is between 220~245Vac.

• Frequency

- In the **OUTPUT SETUP** screen, use the function keys below the symbols  and  to select **FREQ (Hz)** and use the function key below the symbol  to confirm your selection.
- When the symbol  changes to the symbol , use the function keys below the symbols  and  to select output frequency, and use the function key below the symbol  to confirm your setup.

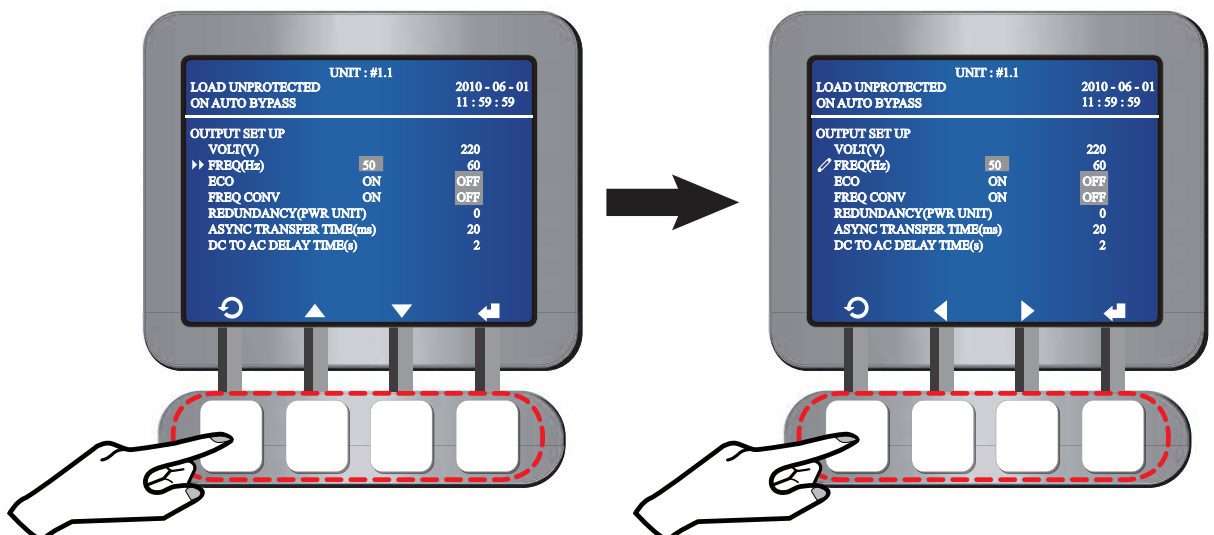

NOTE 

The output frequency means battery start-up output frequency or frequency converter's output frequency.

• **ECO Mode**

1. In the **OUTPUT SETUP** screen, use the function keys below the symbols ▲ and ▼ to select **ECO** and use the function key below the symbol ◀ to confirm your selection.
2. When the symbol ▶▶ changes to the symbol ✎, use the function keys below the symbols ◀ and ▶ to select **ON or OFF**, and use the function key below the symbol ◀ to confirm your selection.

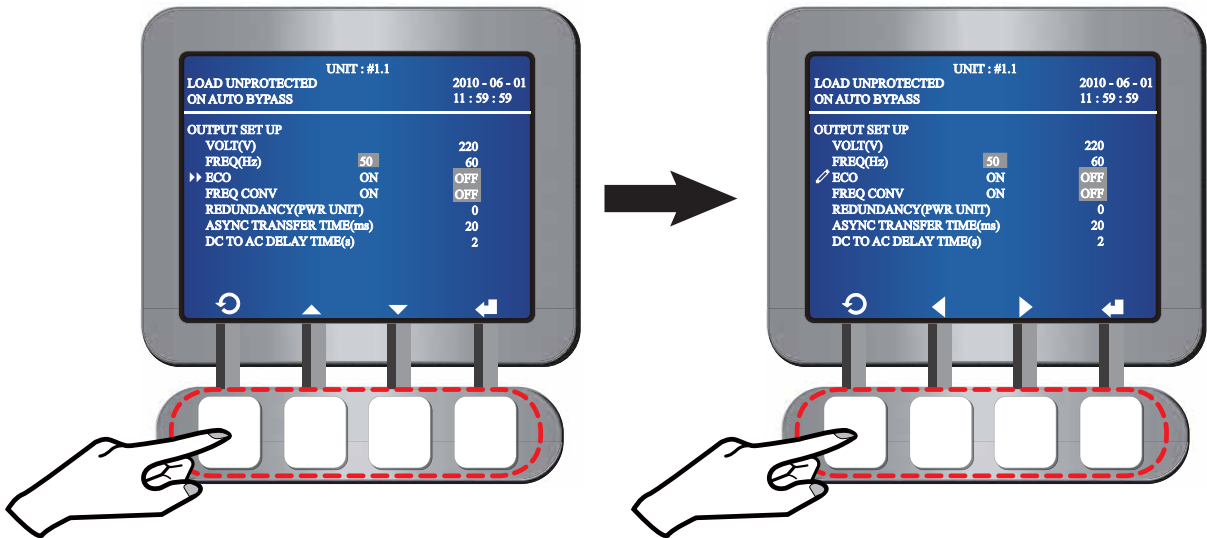

• **Frequency Conversion**

1. In the **OUTPUT SETUP** screen, use the function keys below the symbols ▲ and ▼ to select **FREQ CONV** and use the function key below the symbol ◀ to confirm your selection.
2. When the symbol ▶▶ changes to the symbol ✎, use the function keys below the symbols ◀ and ▶ to select **ON or OFF**, and use the function key below the symbol ◀ to confirm your selection.

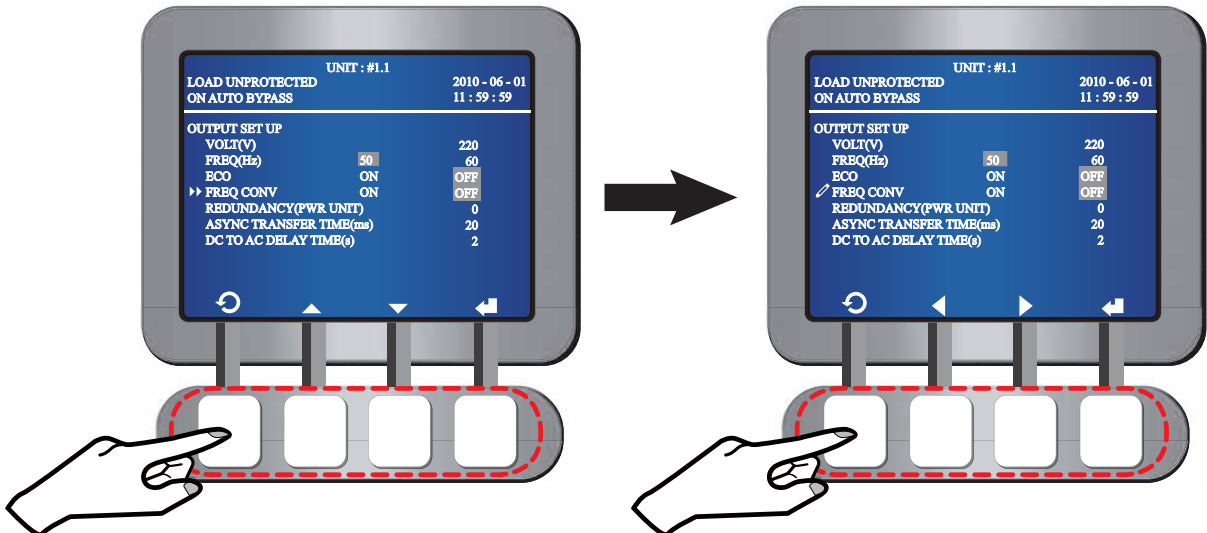

• Redundancy Unit

1. In the **OUTPUT SETUP** screen, use the function keys below the symbols ▲ and ▼ to select **REDUNDANCY (PWR UNIT)** and use the function key below the symbol ◀ to confirm your selection.
2. When the symbol ▶▶ changes to the symbol ✎, use the function keys below the symbols + and - to set up the redundancy unit, and use the function key below the symbol ◀ to confirm your setup.

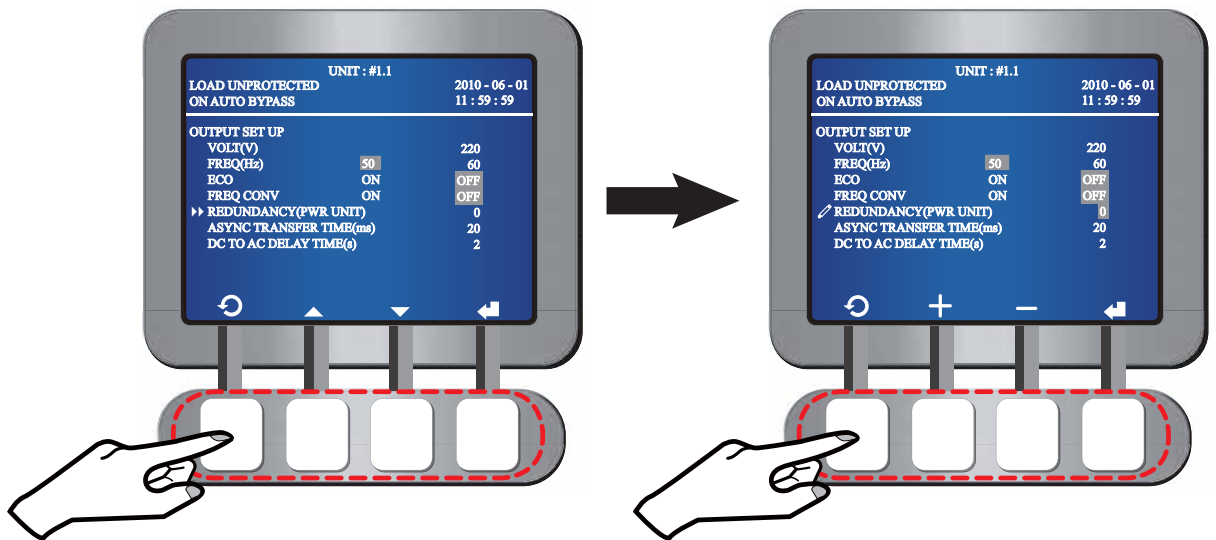

• Asynchronous Transfer Time

1. In the **OUTPUT SETUP** screen, use the function keys below the symbols ▲ and ▼ to select **ASYNC TRANSFER TIME** and use the function key below the symbol ◀ to confirm your selection.
2. When the symbol ▶▶ changes to the symbol ✎, use the function keys below the symbols + and - to set up the asynchronous transfer time, and use the function key below the symbol ◀ to confirm your setup.

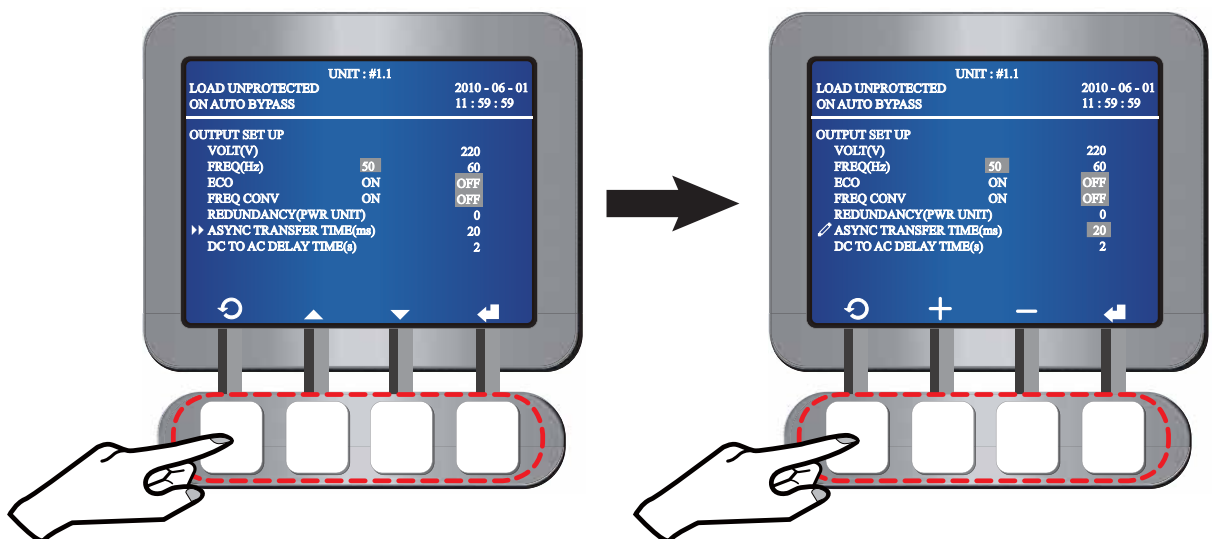

• **DC to AC Delay Time(s)**

1. In the **OUTPUT SETUP** screen, use the function keys below the symbols ▲ and ▼ to select **DC TO AC DELAY TIME(S)** and use the function key below the symbol ◀ to confirm your selection.
2. When the symbol ▶▶ changes to the symbol ✎, use the function keys below the symbols + and - to set up the DC to AC delay time, and use the function key below the symbol ◀ to confirm your setup.

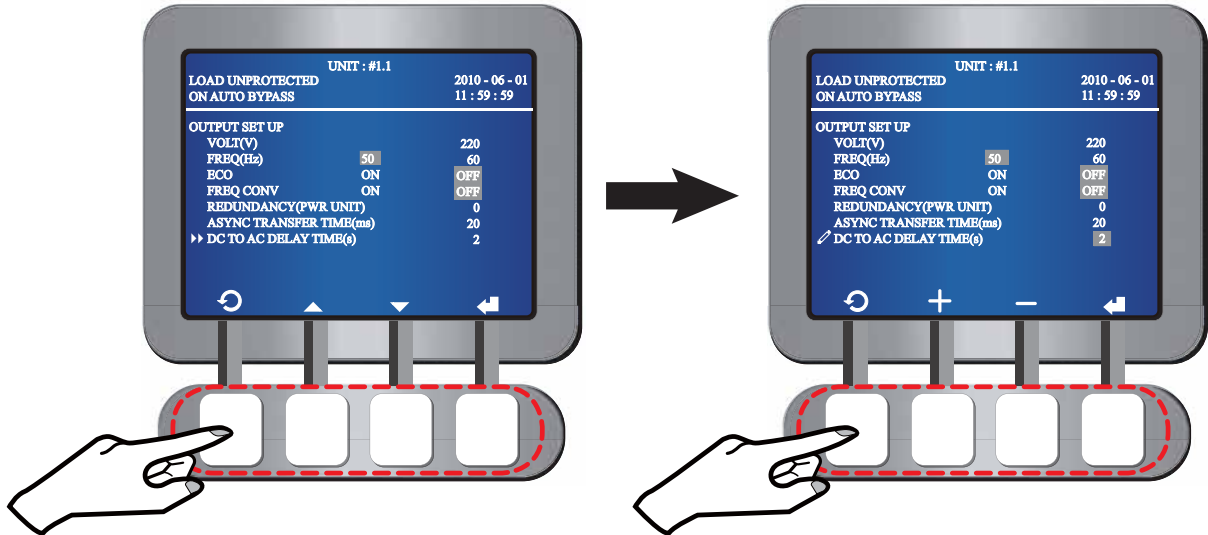

Press the function key below the symbol ↻ to go back to the **UPS SETUP & CONTROL** screen.

7.5.3 Battery Setup



WARNING: You can only modify battery setup in bypass mode.

In the **UPS SETUP & CONTROL** screen, use the function keys below the symbols ▲ and ▼ to select **BATTERY** and press the function key below the symbol ◀ to enter the **BATTERY SETUP** screen. Please see the following LCD diagrams.

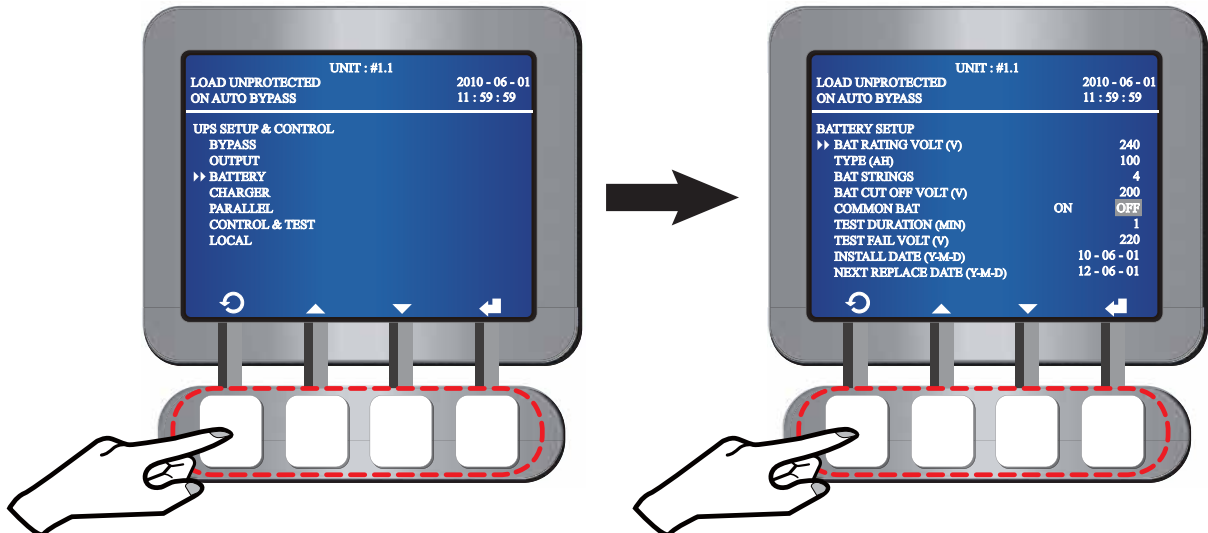

• Battery Rating Voltage

1. In the **BATTERY SETUP** screen, use the function keys below the symbols ▲ and ▼ to select **BAT RATING VOLT (V)** and use the function key below the symbol ◀ to confirm your selection.
2. When the symbol ▶▶ changes to the symbol ✎, use the function keys below the symbols + and - to set up the battery rating voltage, and use the function key below the symbol ◀ to confirm your setup.

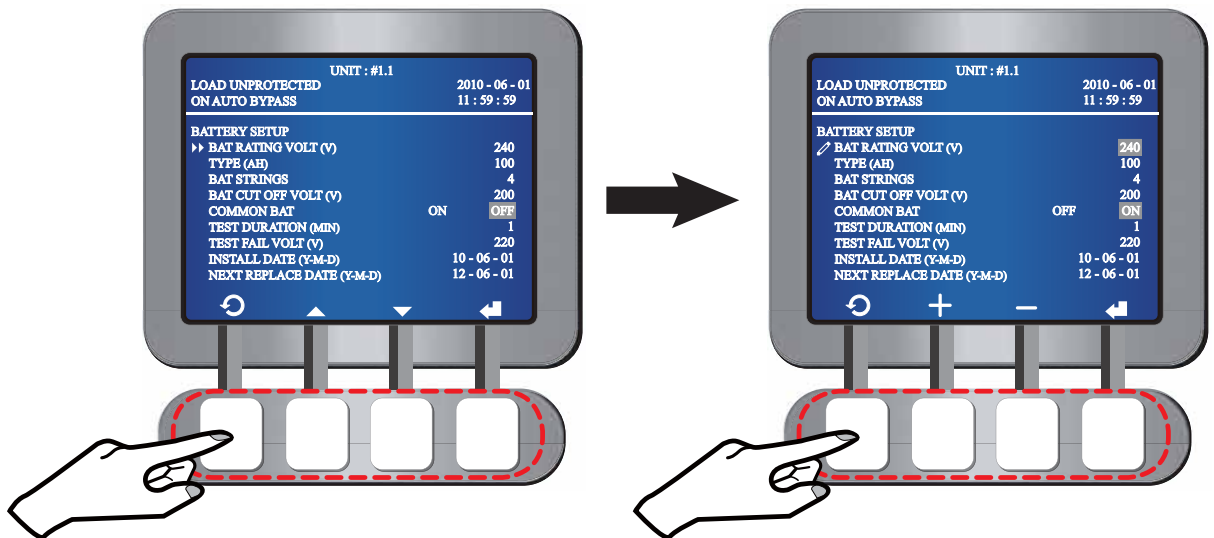

• Battery Type

1. In the **BATTERY SETUP** screen, use the function keys below the symbols ▲ and ▼ to select **TYPE (AH)** and use the function key below the symbol ◀ to confirm your selection.
2. When the symbol ▶▶ changes to the symbol ✎, use the function keys below the symbols + and - to set up the battery type (AH), and use the function key below the symbol ◀ to confirm your setup.

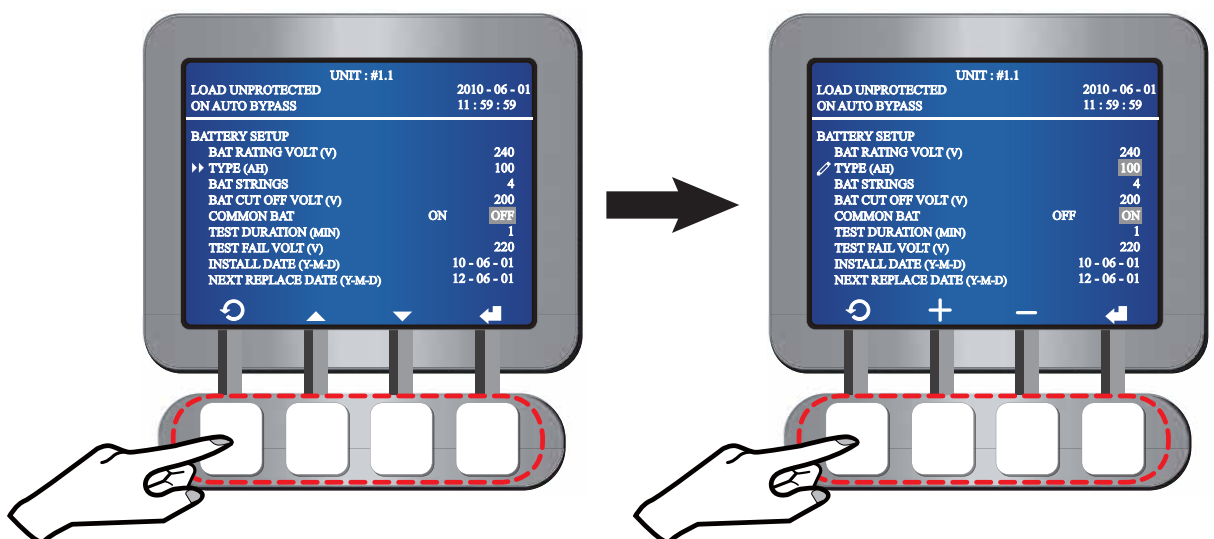

• **Battery Strings**

1. In the **BATTERY SETUP** screen, use the function keys below the symbols ▲ and ▼ to select **BAT STRINGS** and use the function key below the symbol ◀ to confirm your selection.
2. When the symbol ▶▶ changes to the symbol ✎, use the function keys below the symbols + and - to set up the battery strings, and use the function key below the symbol ◀ to confirm your setup.

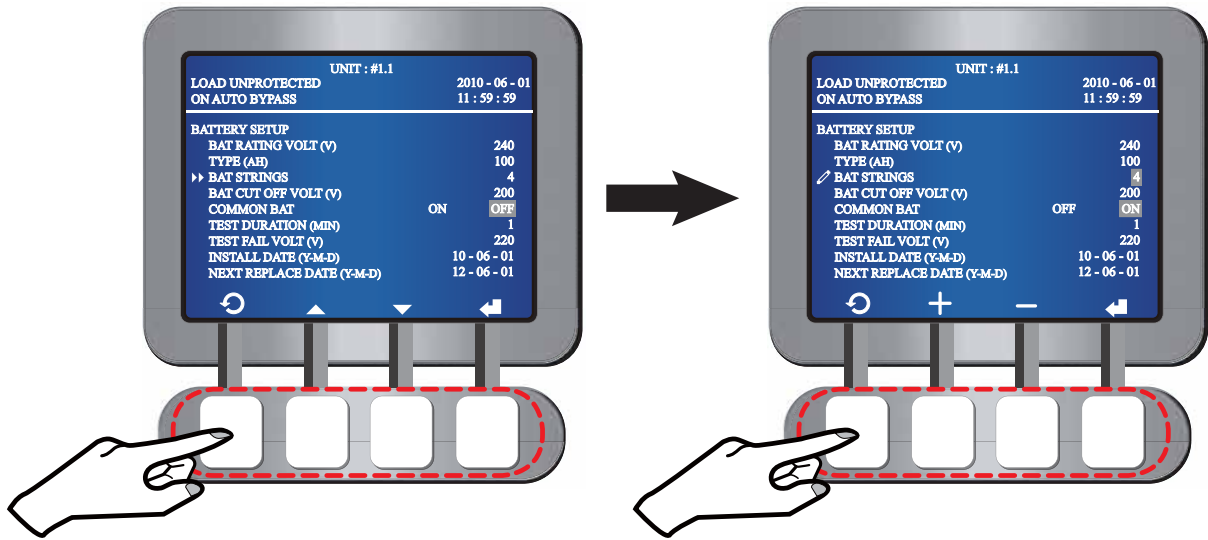

• **Battery Cut-off Voltage**

1. In the **BATTERY SETUP** screen, use the function keys below the symbols ▲ and ▼ to select **BAT CUT OFF VOLT (V)** and use the function key below the symbol ◀ to confirm your selection.
2. When the symbol ▶▶ changes to the symbol ✎, use the function keys below the symbols + and - to set up the battery cut-off voltage, and use the function key below the symbol ◀ to confirm your setup.

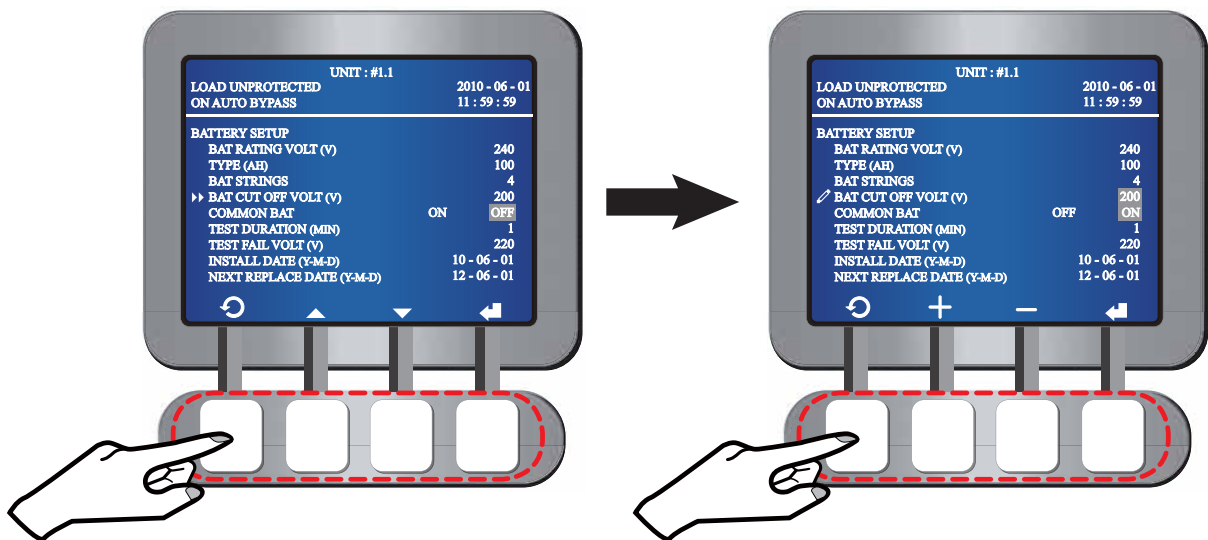

- **Common Battery**

1. In the **BATTERY SETUP** screen, use the function keys below the symbols ▲ and ▼ to select **COMMON BAT** and use the function key below the symbol ◀ to confirm your selection.
2. When the symbol ▶▶ changes to the symbol ✎, use the function keys below the symbols ◀ and ▶ to select **ON or OFF**, and use the function key below the symbol ◀ to confirm your selection.

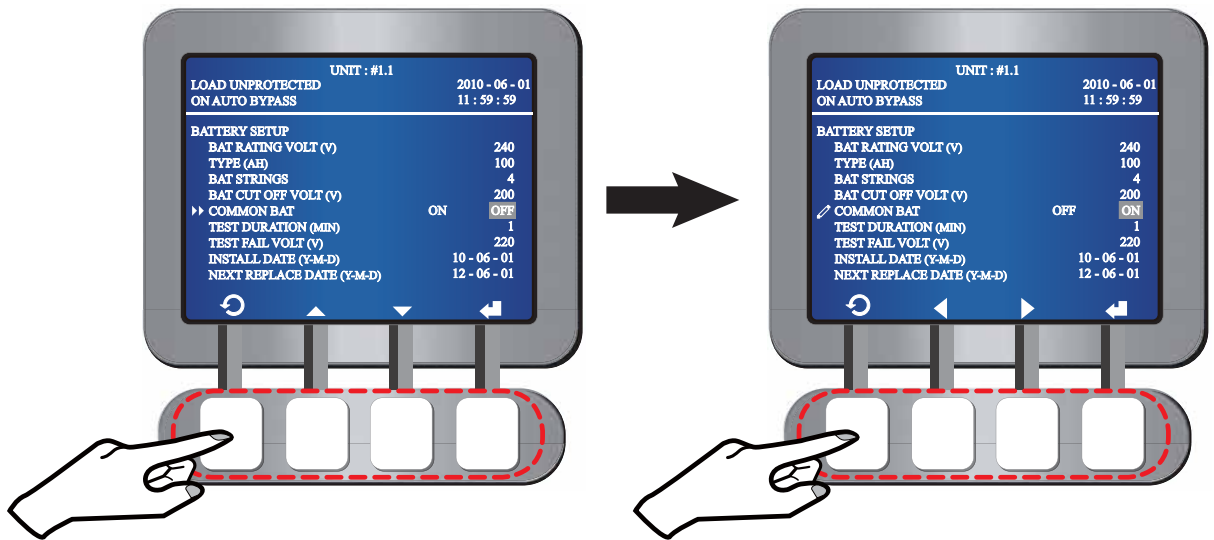

- **Battery Test Duration**

1. In the **BATTERY SETUP** screen, use the function keys below the symbols ▲ and ▼ to select **TEST DURATION (MIN)** and use the function key below the symbol ◀ to confirm your selection.
2. When the symbol ▶▶ changes to the symbol ✎, use the function keys below the symbols + and - to set up the battery test duration, and use the function key below the symbol ◀ to confirm your setup.

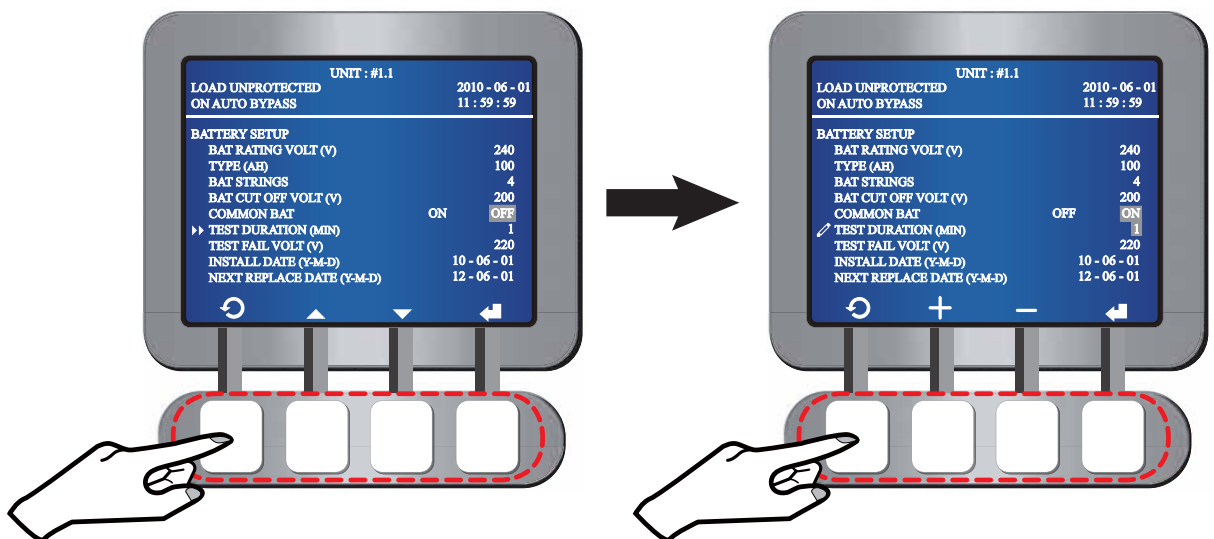

• **Test Fail Voltage**

1. In the **BATTERY SETUP** screen, use the function keys below the symbols ▲ and ▼ to select **TEST FAIL VOLT (V)** and use the function key below the symbol ◀ to confirm your selection.
2. When the symbol ▶▶ changes to the symbol ✎, use the function keys below the symbols + and - to set up the test fail voltage, and use the function key below the symbol ◀ to confirm your setup.

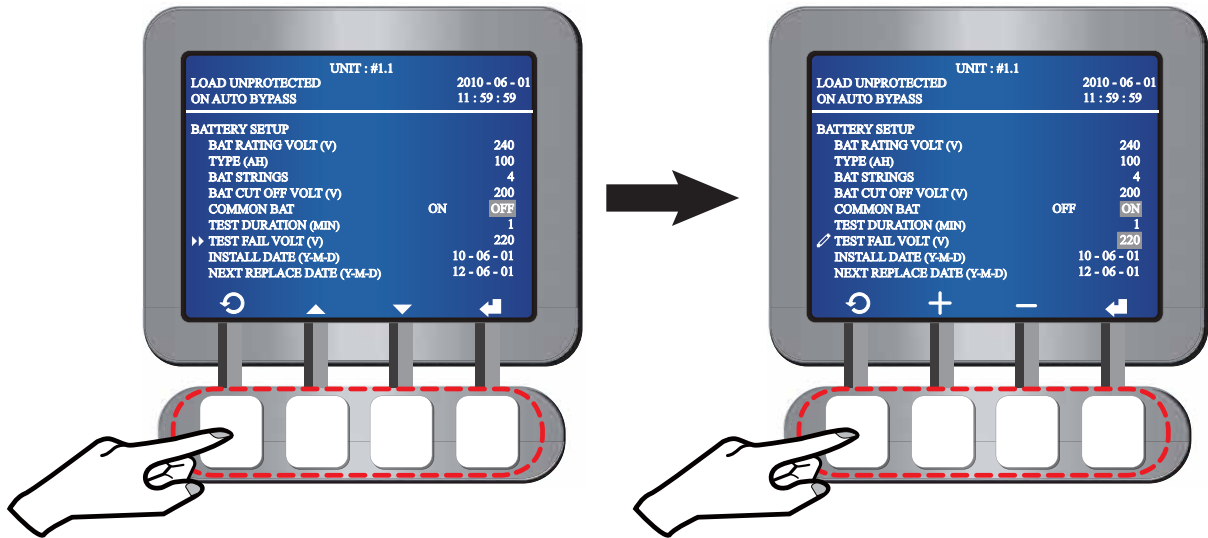

• **Installation Date**

1. In the **BATTERY SETUP** screen, use the function keys below the symbols ▲ and ▼ to select **INSTALL DATE (Y-M-D)** and use the function key below the symbol ◀ to confirm your selection.
2. When the symbol ▶▶ changes to the symbol ✎, use the function keys below the symbols + and - to set up the installation date, and use the function key below the symbol ◀ to confirm your setup.

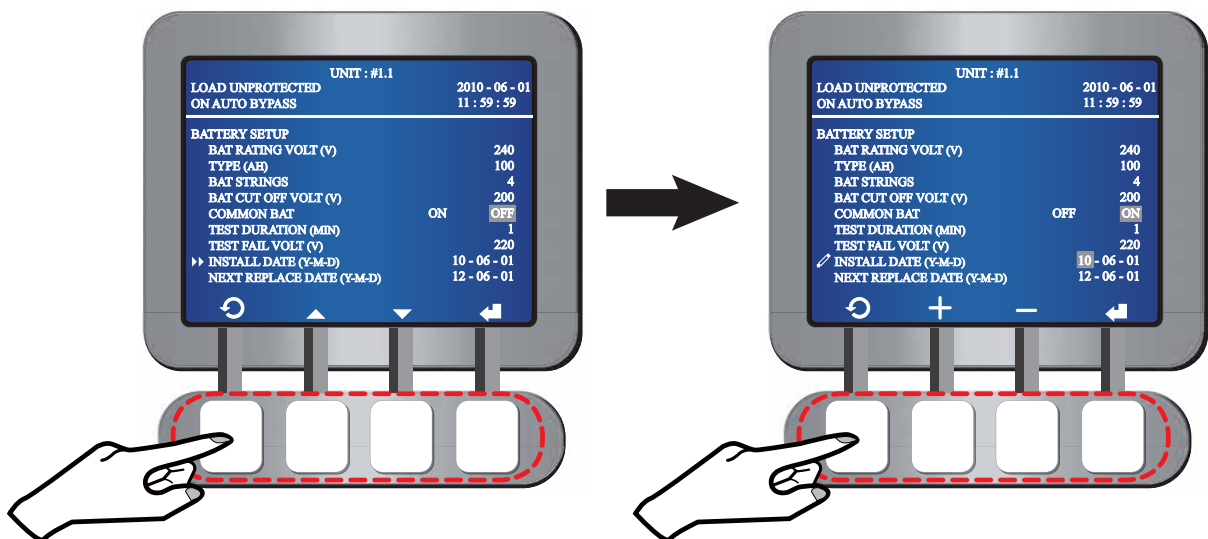

• Battery Replacement Date

1. In the **BATTERY SETUP** screen, use the function keys below the symbols ▲ and ▼ to select **NEXT REPLACE DATE (Y-M-D)** and use the function key below the symbol ◀ to confirm your selection.
2. When the symbol ▶▶ changes to the symbol ✎, use the function keys below the symbols + and - to set up the battery replacement date, and use the function key below the symbol ◀ to confirm your setup.

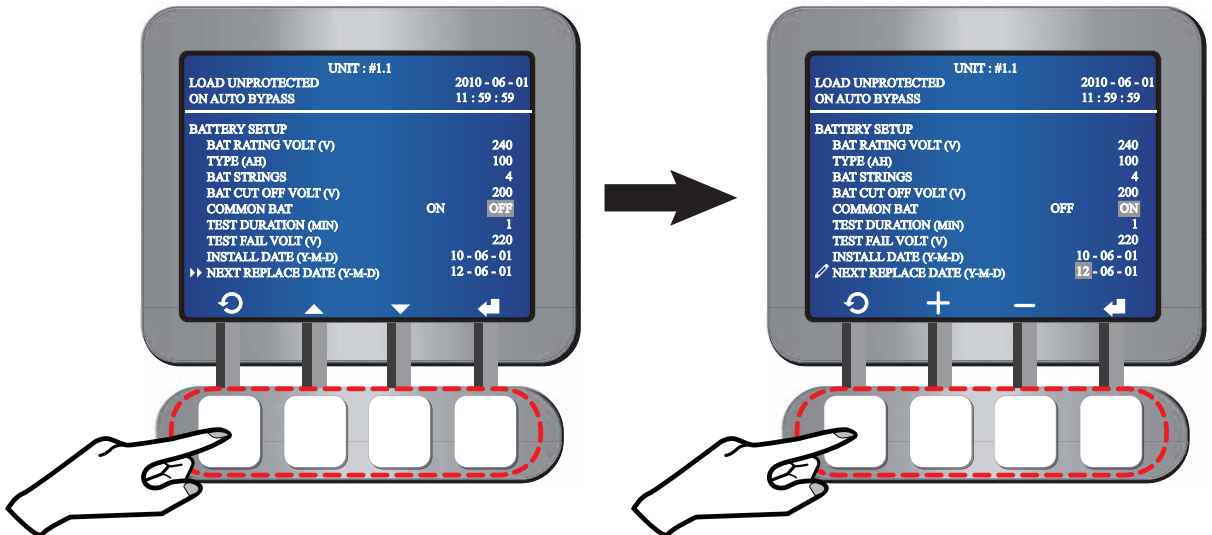

When the battery replacement date is reached, the LCD shows an alarm message.

Press the function key below the symbol ↻ to go back to the **UPS SETUP & CONTROL** screen.

7.5.4 Charger Setup

In the **UPS SETUP & CONTROL** screen, use the function keys below the symbols ▲ and ▼ to select **CHARGER** and press the function key below the symbol ◀ to enter the **CHARGER SETUP** screen. Please see the following LCD diagrams.

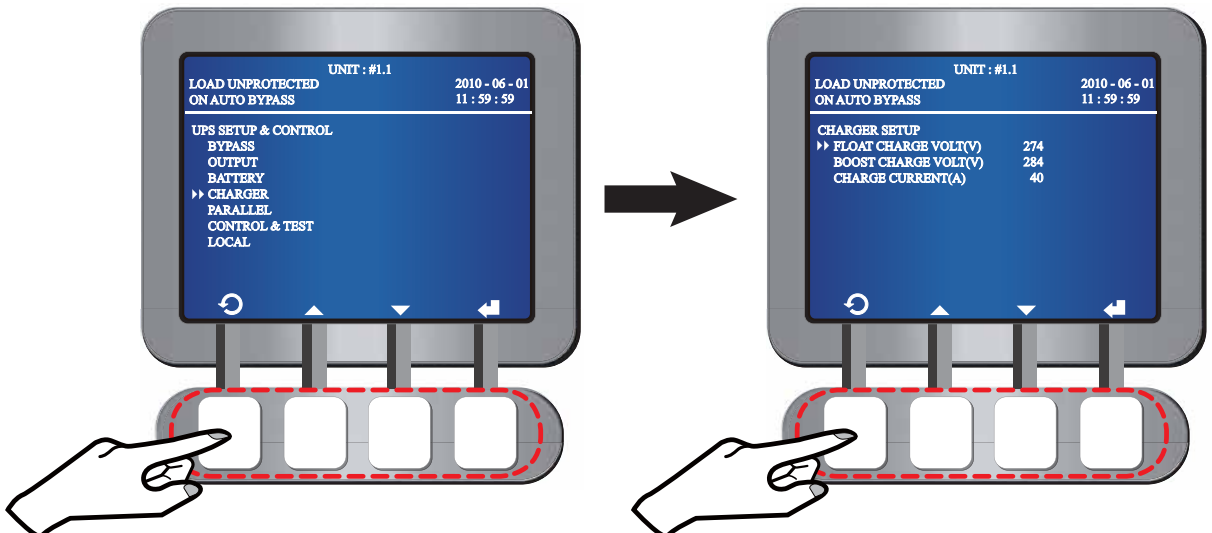

• **Float Voltage**

1. In the **CHARGER SETUP** screen, use the function keys below the symbols ▲ and ▼ to select **FLOAT CHARGE VOLT (V)** and use the function key below the symbol ◀ to confirm your selection.
2. When the symbol ▶▶ changes to the symbol ✎, use the function keys below the symbols + and - to set up the float voltage, and use the function key below the symbol ◀ to confirm your setup.

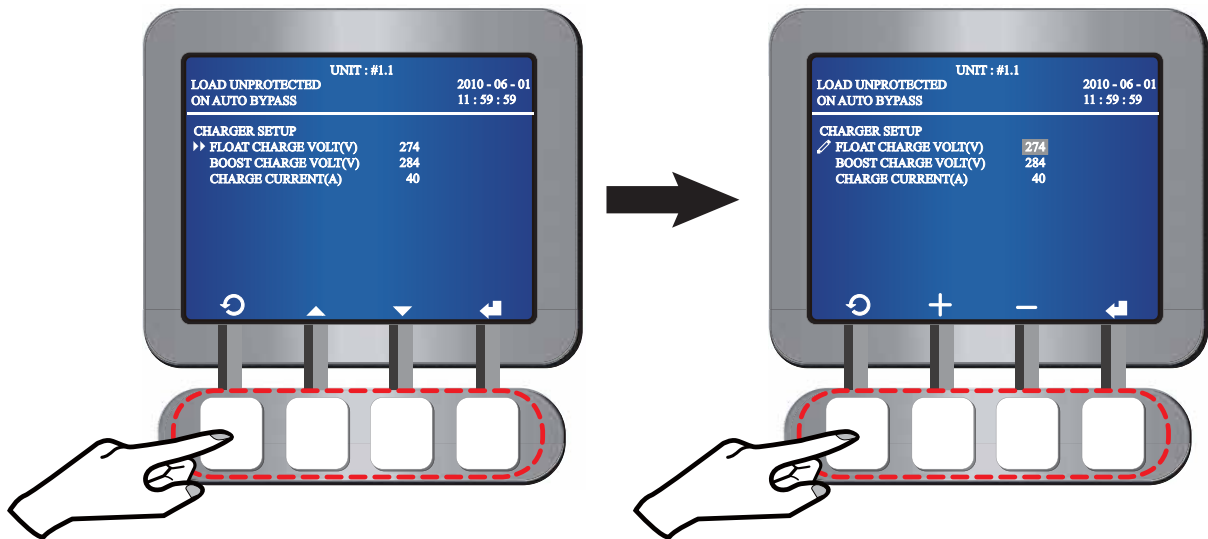

• **Boost Voltage**

1. In the **CHARGER SETUP** screen, use the function keys below the symbols ▲ and ▼ to select **BOOST CHARGE VOLT (V)** and use the function key below the symbol ◀ to confirm your selection.
2. When the symbol ▶▶ changes to the symbol ✎, use the function keys below the symbols + and - to set up the boost voltage, and use the function key below the symbol ◀ to confirm your setup.

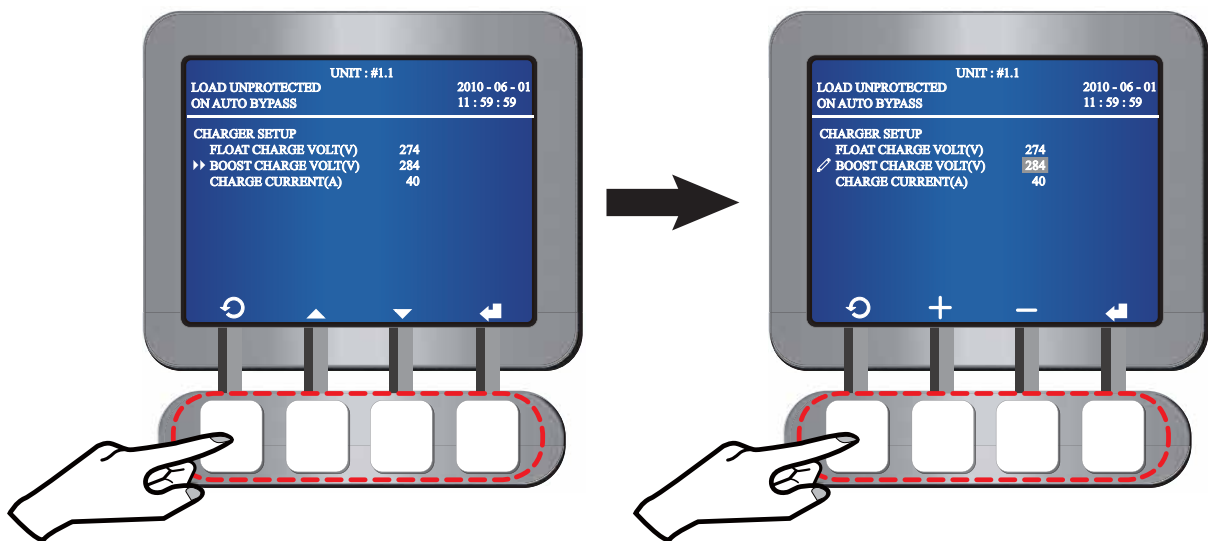

- **Charge Current**

1. In the **CHARGER SETUP** screen, use the function keys below the symbols ▲ and ▼ to select **CHARGE CURRENT** and use the function key below the symbol ◀ to confirm your selection.
2. When the symbol ▶▶ changes to the symbol ✎, use the function keys below the symbols + and - to set up the charge current, and use the function key below the symbol ◀ to confirm your setup.

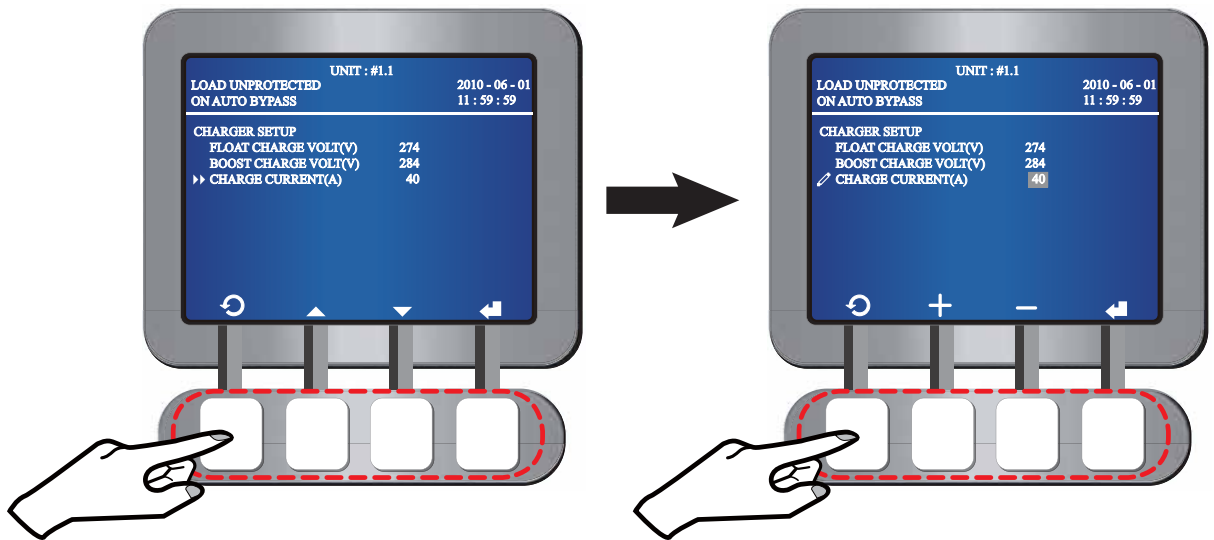

Press the function key below the symbol ↻ to go back to the **UPS SETUP & CONTROL** screen.

7.5.5 Parallel Setup



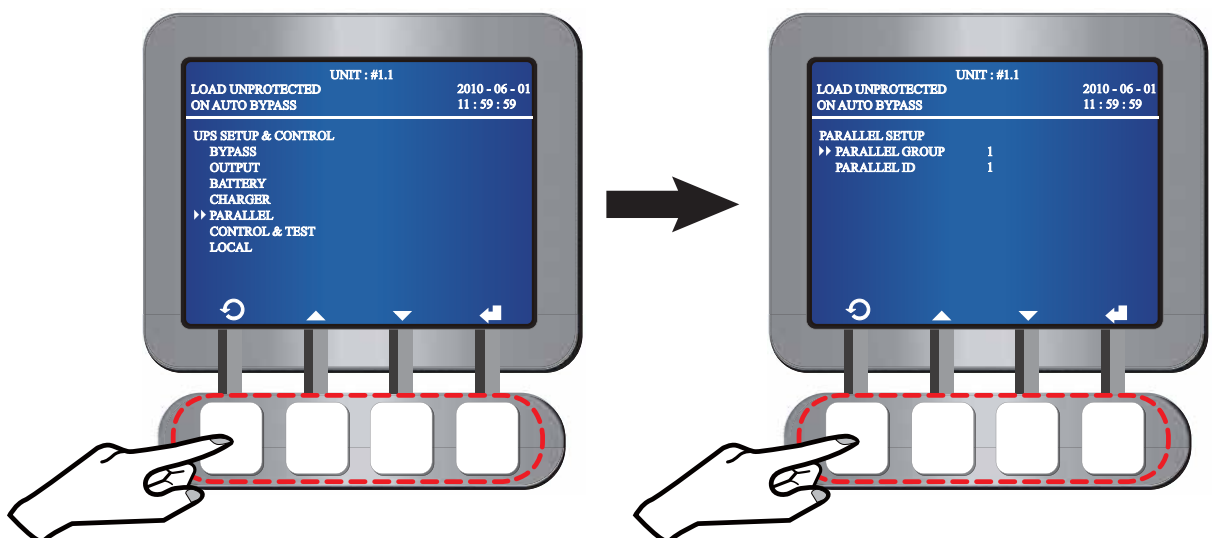

In the **UPS SETUP & CONTROL** screen, use the function keys below the symbols ▲ and ▼ to select **PARALLEL** and press the function key below the symbol ◀ to enter into **PARALLEL SETUP** screen. Please see the following LCD diagrams.



- **Parallel Group**

1. In the **PARALLEL SETUP** screen, use the function keys below the symbols ▲ and ▼

to select **PARALLEL GROUP** and use the function key below the symbol  to confirm your selection.



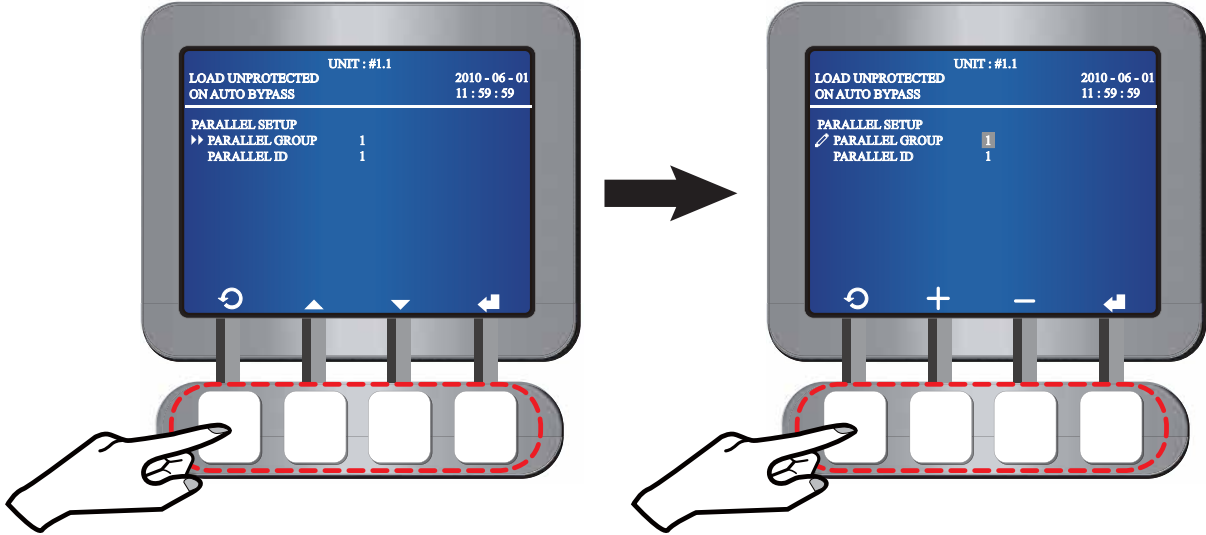





- When the symbol  changes to the symbol , use the function keys below the symbols  and  to set up the parallel group, and use the function key below the symbol  to confirm your setup.



NOTE 

Set the parallel group as 1 when there is no Load Bus Synchronization application. If you need the Load Bus Synchronization application, please contact your local dealer or customer service representative.

• **Parallel ID**

- In the **PARALLEL SETUP** screen, use the function keys below the symbols  and  to select **PARALLEL ID** and use the function key below the symbol  to confirm your selection.
- When the symbol  changes to the symbol , use the function keys below the symbols  and  to set up the parallel ID, and use the function key below the symbol  to confirm your setup.

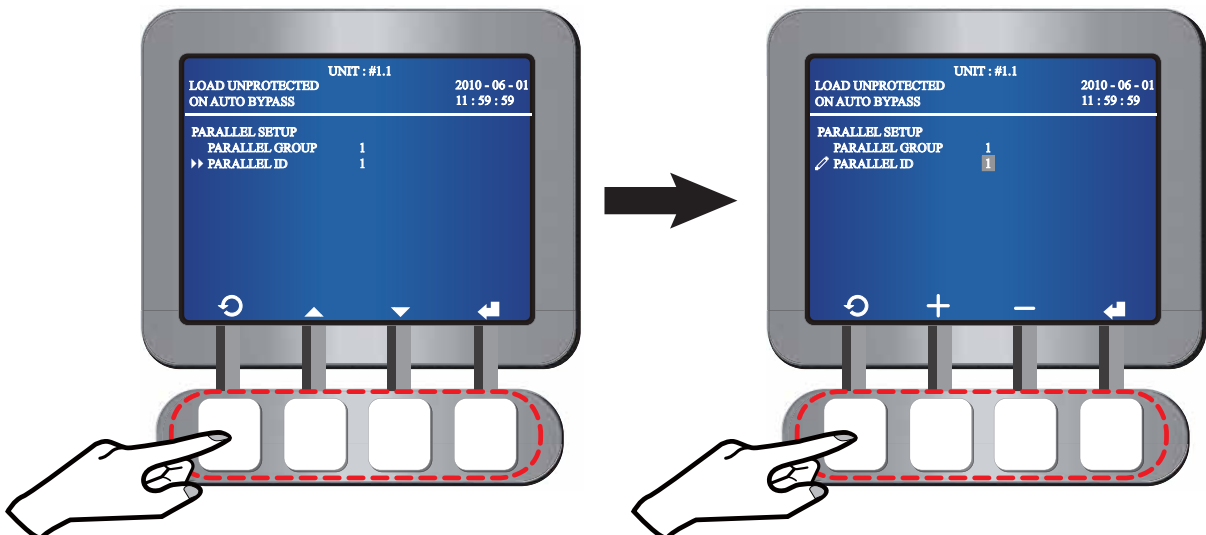



**NOTE**

You can parallel UPSs at maximum eight and set Parallel IDs as #1, #2, #3, #4, #5, #6, #7 and #8.







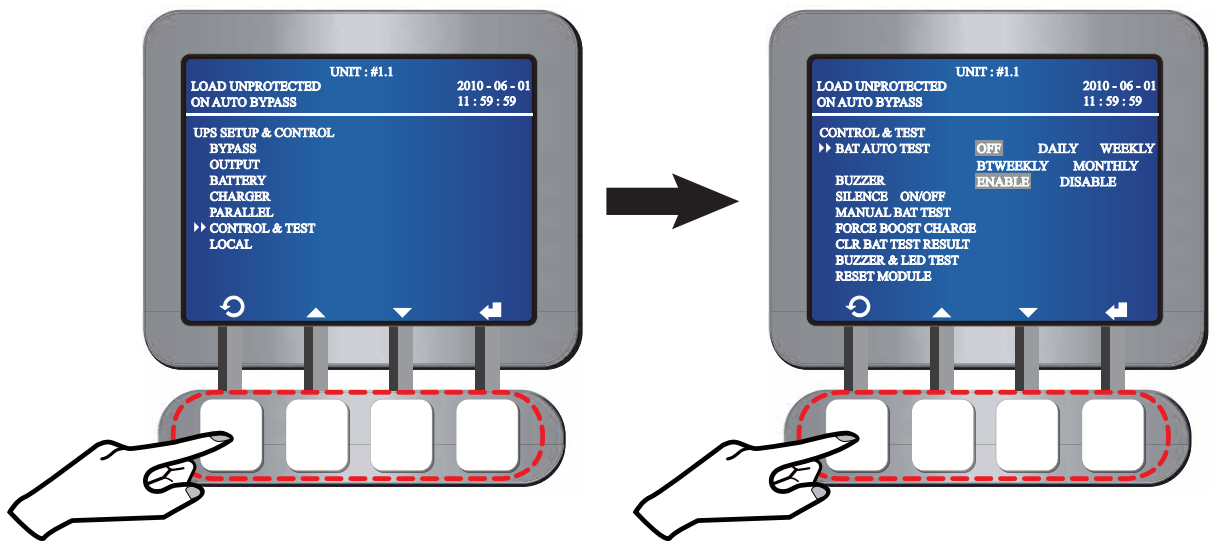

Press the function key below the symbol  to go back to the **UPS SETUP & CONTROL** screen.

7.5.6 Control & Test Setup

In the **UPS SETUP & CONTROL** screen, use the function keys below the symbols  and  to select **CONTROL & TEST** and press the function key below the symbol  to enter into **CONTROL & TEST** screen. Please see the following LCD diagrams.



- **Battery Auto Test**

1. In the **CONTROL & TEST** screen, use the function keys below the symbols  and  to select **BAT AUTO TEST** and use the function key below the symbol  to confirm your selection.
2. When the symbol  changes to the symbol , use the function keys below the symbols  and  to select **OFF, DAILY, WEEKLY, BIWEEKLY, or MONTHLY** and use the function key below the symbol  to confirm your selection.

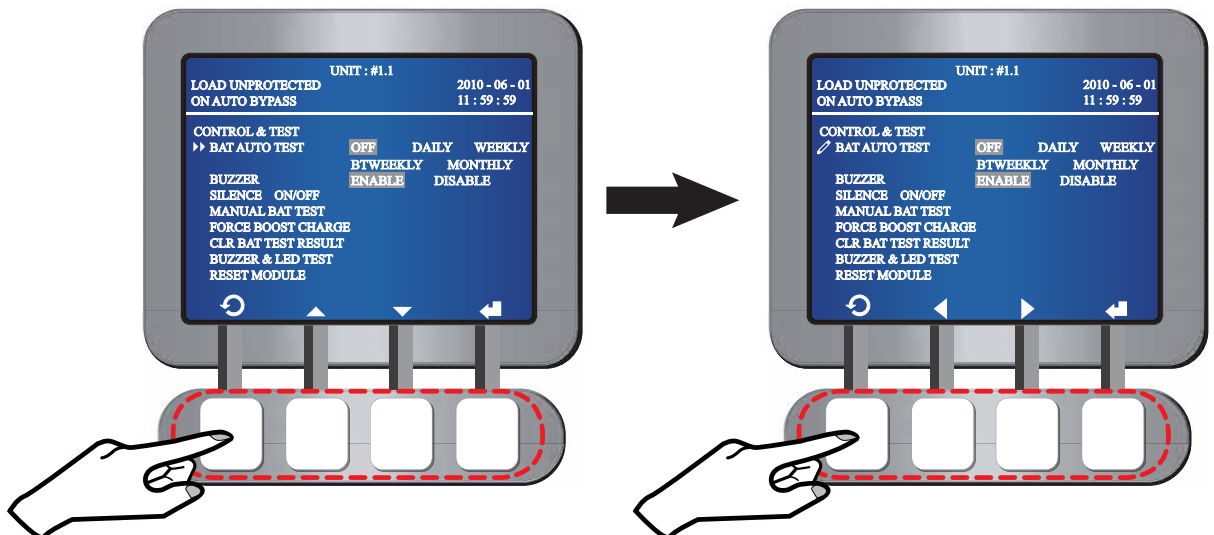

• **Buzzer**

1. In the **CONTROL & TEST** screen, use the function keys below the symbols ▲ and ▼ to select **BUZZER** and use the function key below the symbol ◀ to confirm your selection.
2. When the symbol ▶▶ changes to the symbol ✎, use the function keys below the symbols ◀ and ▶ to select **ENABLE or DISABLE**, and use the function key below the symbol ◀ to confirm your selection.

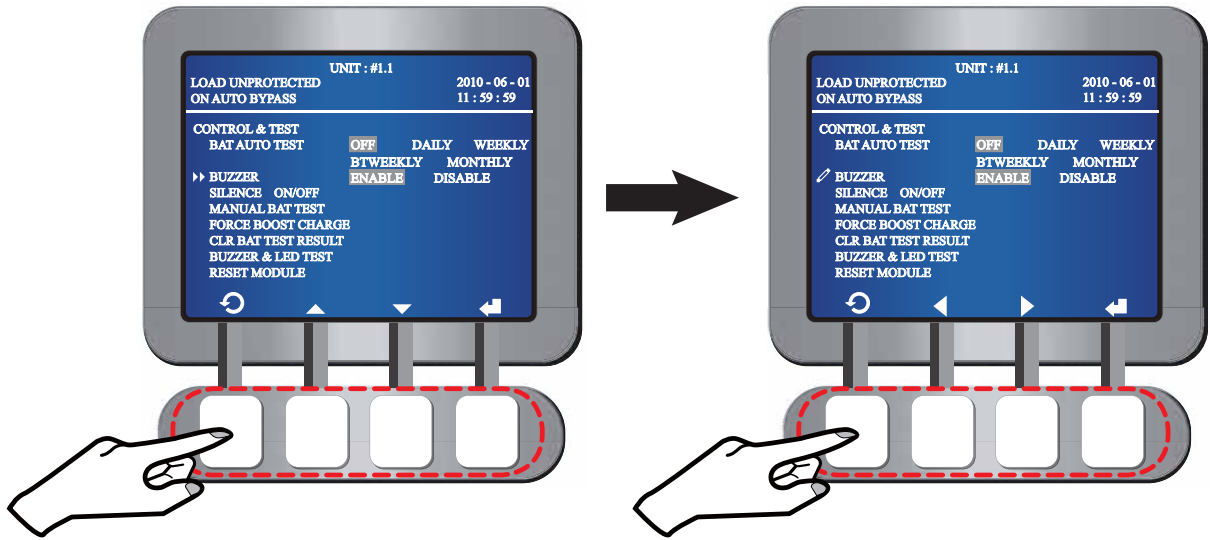

• **To Silence Alarms**

1. In the **CONTROL & TEST** screen, use the function keys below the symbols ▲ and ▼ to select **SILENCE ON/ OFF** and use the function key below the symbol ◀ to confirm your selection.
2. When the symbol ▶▶ changes to the symbol ✎, press the function key below the symbol ◀ to confirm your selection.

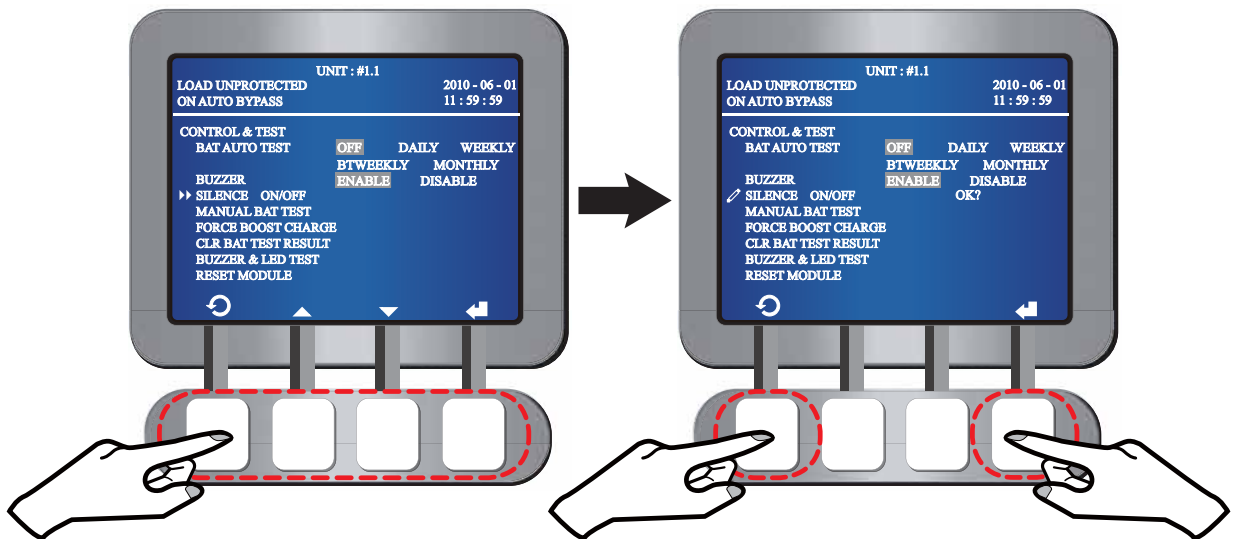

• Manual Battery Test

1. In the **CONTROL & TEST** screen, use the function keys below the symbols ▲ and ▼ to select **MANUAL BAT TEST** and use the function key below the symbol ◀ to confirm your selection.
2. When the symbol ▶▶ changes to the symbol ✎, press the function key below the symbol ◀ to confirm your selection.

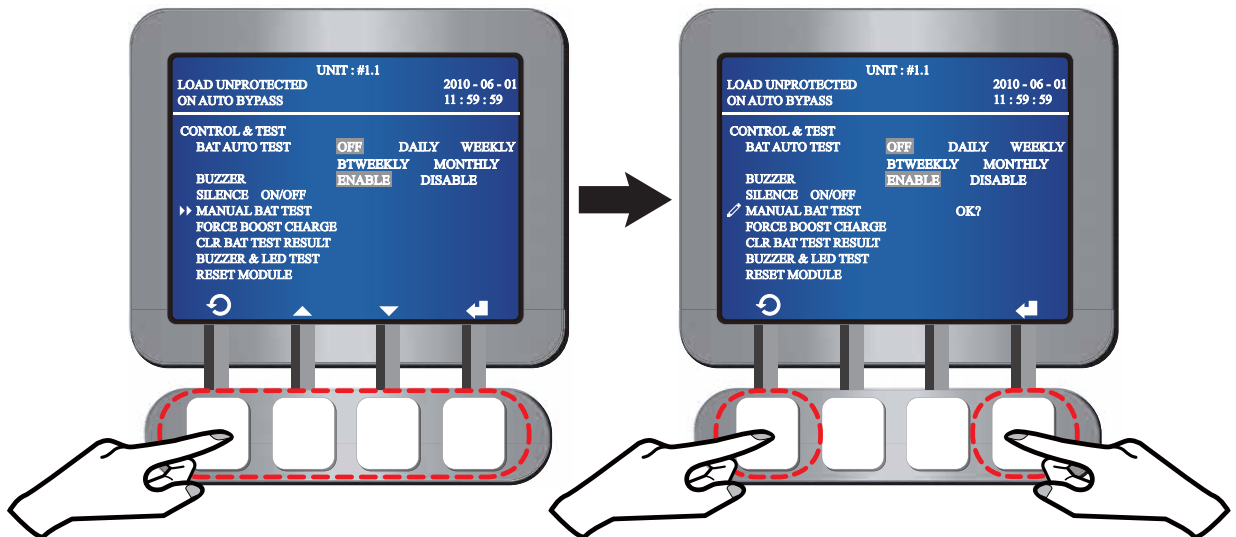

• To Force Boost Charge

1. In the **CONTROL & TEST** screen, use the function keys below the symbols ▲ and ▼ to select **FORCE BOOST CHARGE** and use the function key below the symbol ◀ to confirm your selection.
2. When the symbol ▶▶ changes to the symbol ✎, press the function key below the symbol ◀ to confirm your selection.

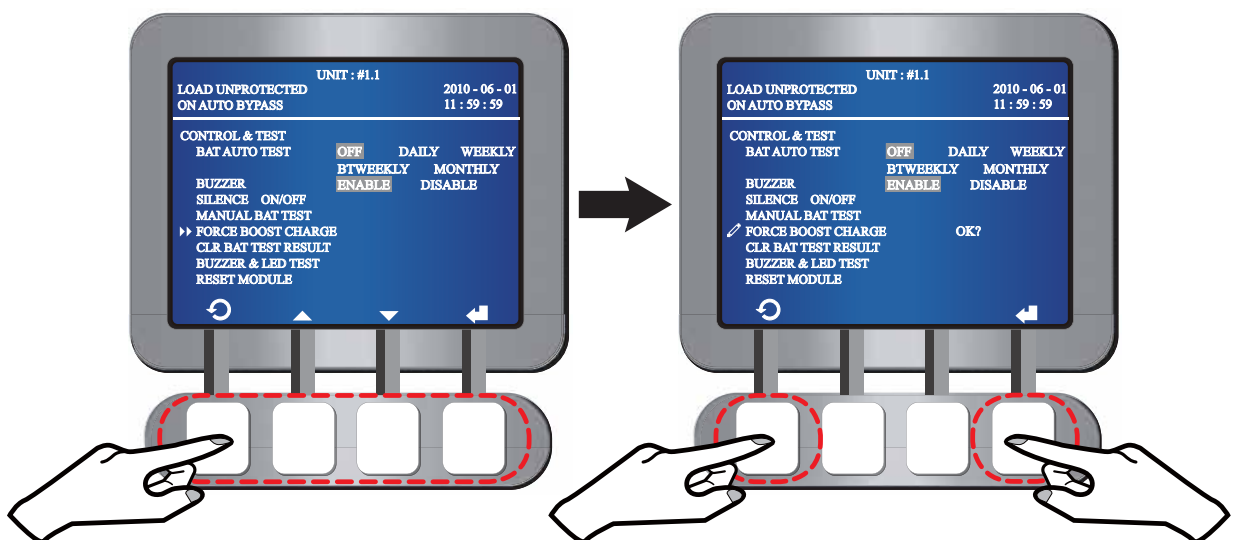

• **To Clear Battery Test Result**

1. In the **CONTROL & TEST** screen, use the function keys below the symbols ▲ and ▼ to select **CLR BAT TEST RESULT** and use the function key below the symbol ◀ to confirm your selection.
2. When the symbol ▶▶ changes to the symbol ✎, press the function key below the symbol ◀ to confirm your selection.

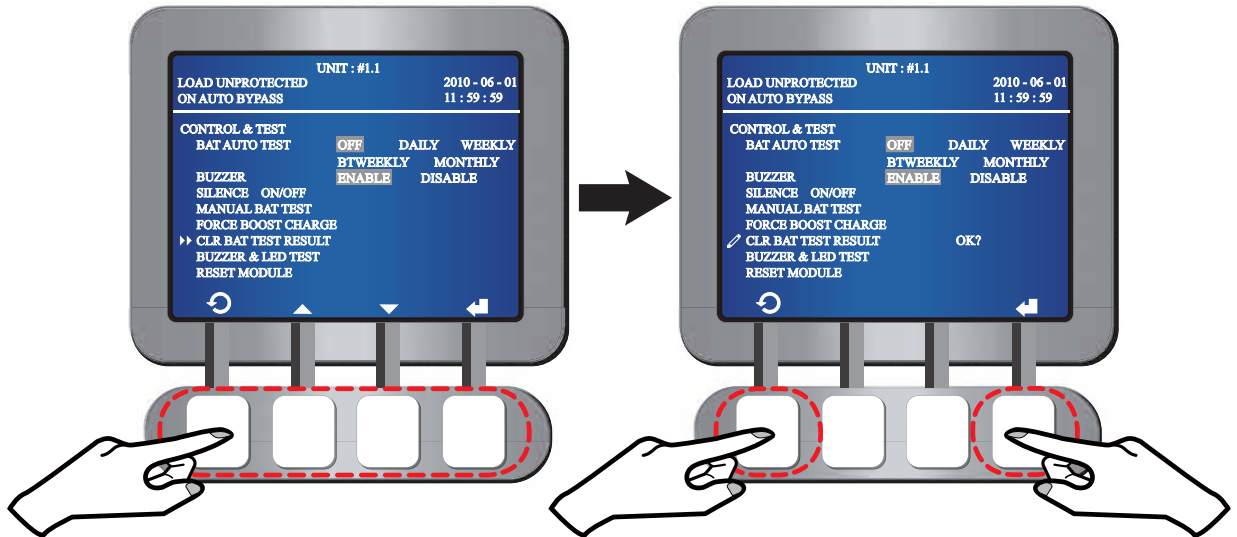

NOTE

Once you press the function key below the symbol ◀ to confirm your selection, all battery test results will be cleared.

• **Buzzer & LED Test**

1. In the **CONTROL & TEST** screen, use the function keys below the symbols ▲ and ▼ to select **BUZZER & LED TEST** and use the function key below the symbol ◀ to confirm your selection.
2. When the symbol ▶▶ changes to the symbol ✎, press the function key below the symbol ◀ to confirm your selection.

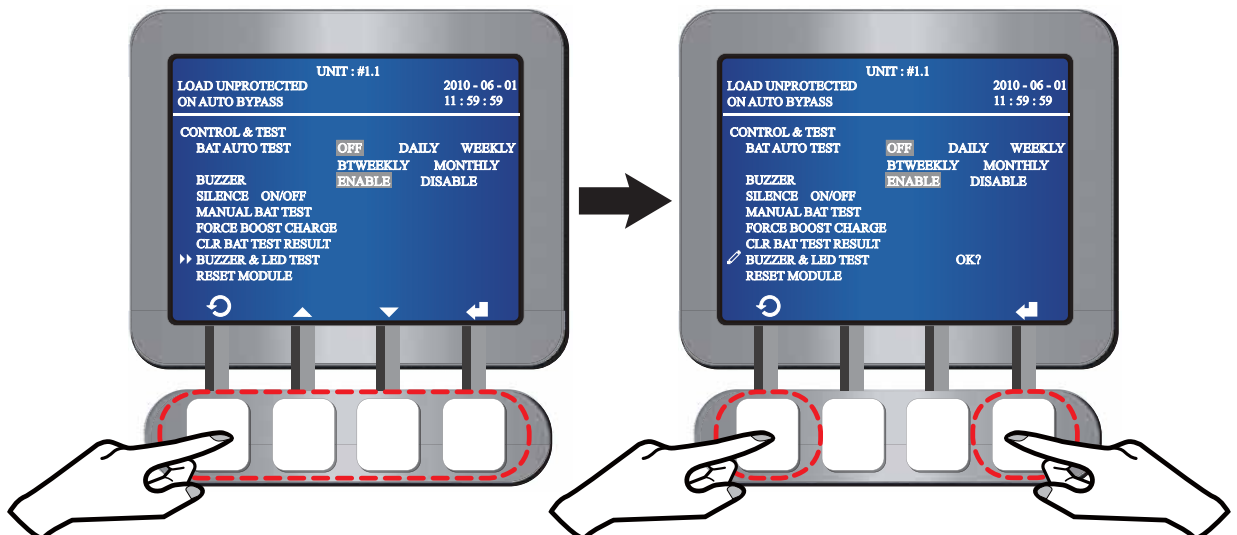

• Reset Module

1. In the **CONTROL & TEST** screen, use the function keys below the symbols ▲ and ▼ to select **RESET MODULE** and use the function key below the symbol ◀ to confirm your selection.
2. When the symbol ▶▶ changes to the symbol ✎, press the function key below the symbol ◀ to confirm your selection.

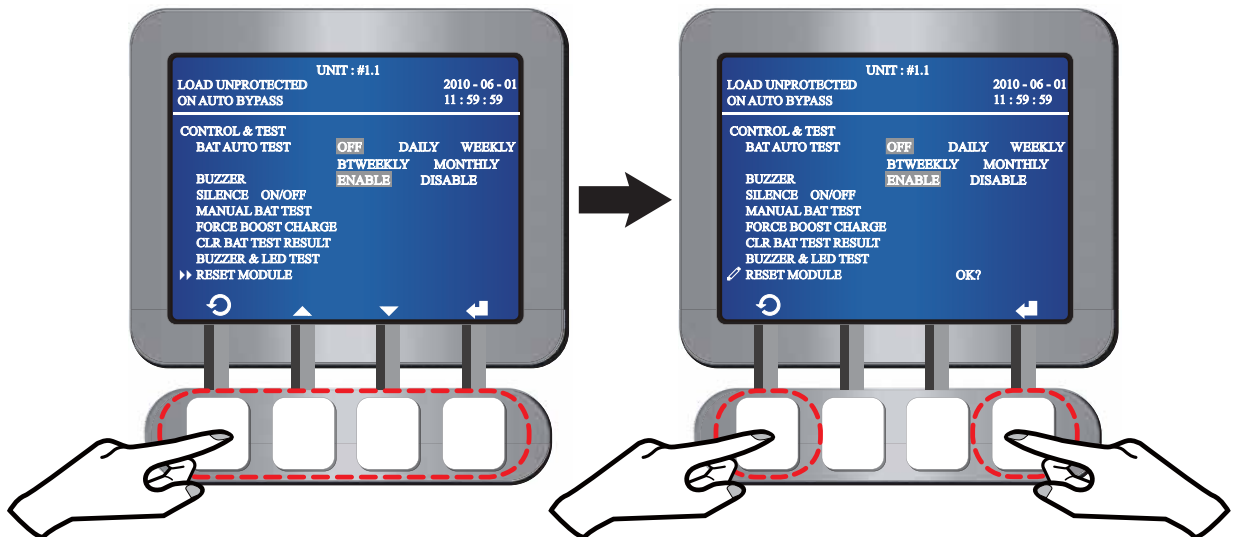

Press the function key below the symbol ↻ to go back to the **UPS SETUP & CONTROL** screen.

7.5.7 Local Setup



In **LOCAL** screen, users can only set up (1) **DATE & TIME**, (2) **DATE FORMAT**, (3) **LCD CONTRAST**, (4) **USER PASSWORD** and (5) **LANGUAGE**.

In the **UPS SETUP & CONTROL** screen, use the function keys below the symbols ▲ and ▼ to select **LOCAL** and press the function key below the symbol ◀ to enter into LOCAL screen. Please see the following LCD diagrams.

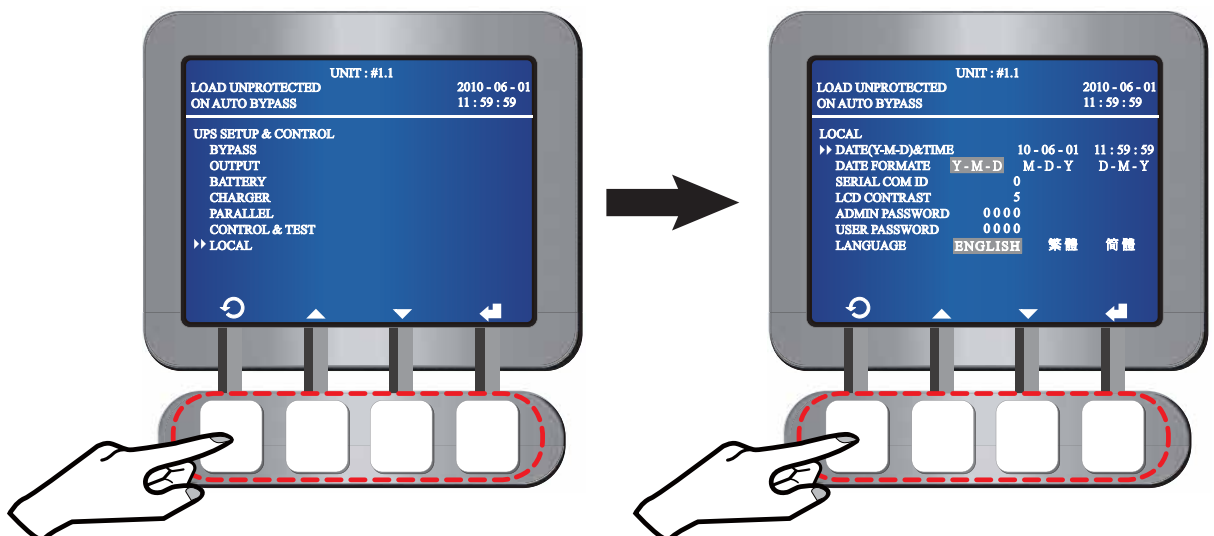

• Date & Time

1. In the **LOCAL** screen, use the function keys below the symbols ▲ and ▼ to select **DATE (Y-M-D) & TIME** and use the function key below the symbol ◀ to confirm your selection.
2. When the symbol ▶▶ changes to the symbol ✎, use the function keys below the symbols + and - to set up the date and time, and press the function key below the symbol ◀ to confirm your setup.

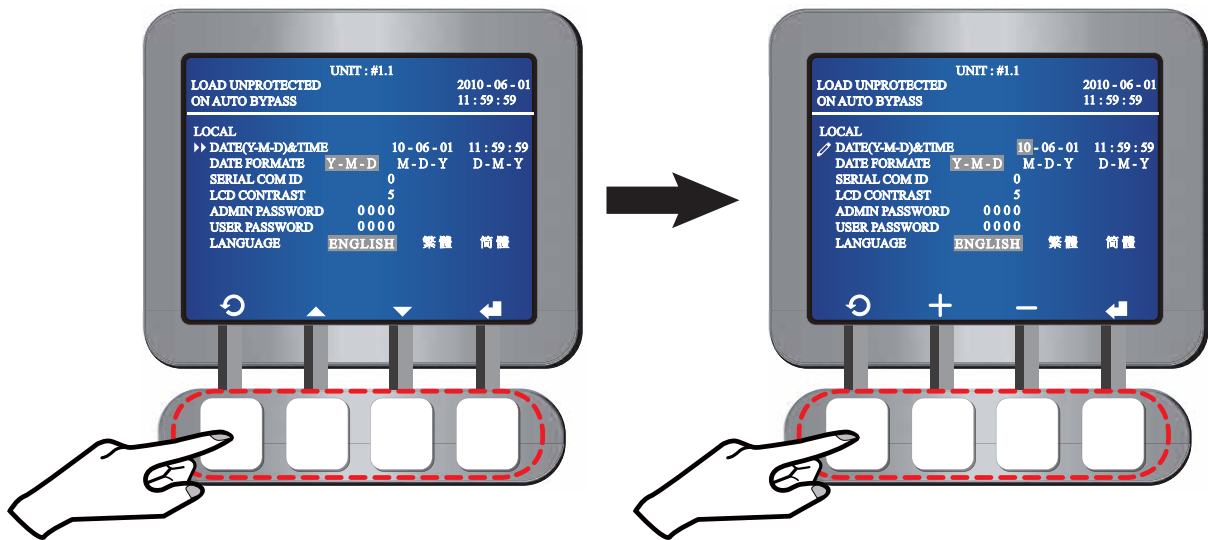

• Date Format

1. In the **LOCAL** screen, use the function keys below the symbols ▲ and ▼ to select **DATE FORMAT** and use the function key below the symbol ◀ to confirm your selection.
2. When the symbol ▶▶ changes to the symbol ✎, use the function keys below the symbols ◀ and ▶ to select **Y-M-D, M-D-Y, or D-M-Y** and press the function key below the symbol ◀ to confirm your selection.

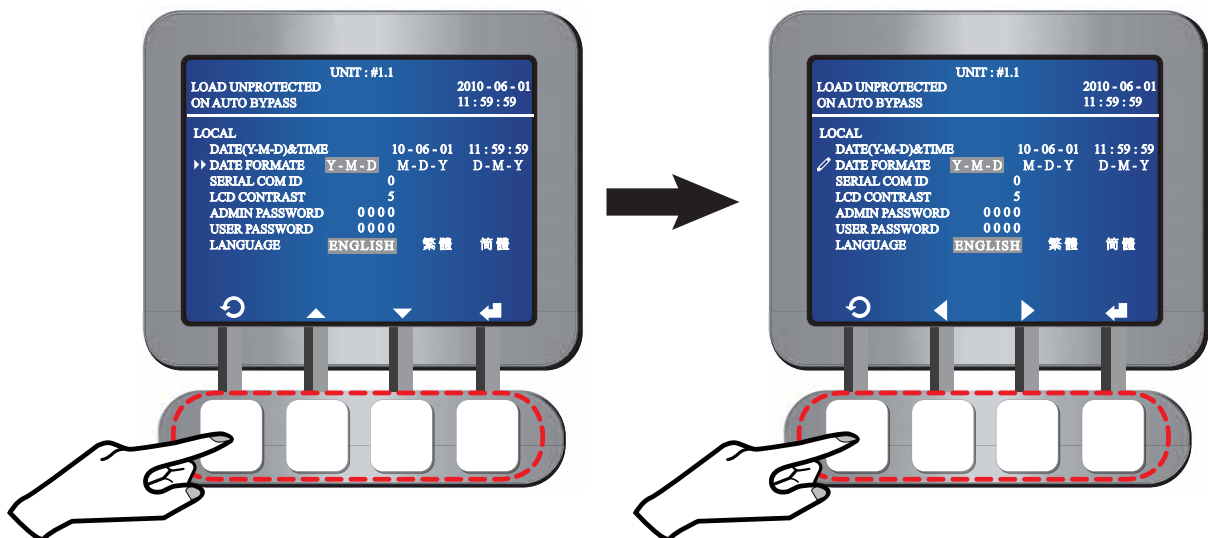

• Serial Communication ID

1. In the **LOCAL** screen, use the function keys below the symbols ▲ and ▼ to select **SERIAL COM ID** and press the function key below the symbol ◀ to confirm your selection.
2. When the symbol ▶▶ changes to the symbol ✎, use the function keys below the symbols + and - to set up the serial communication ID, and press the function key below the symbol ◀ to confirm your setup.

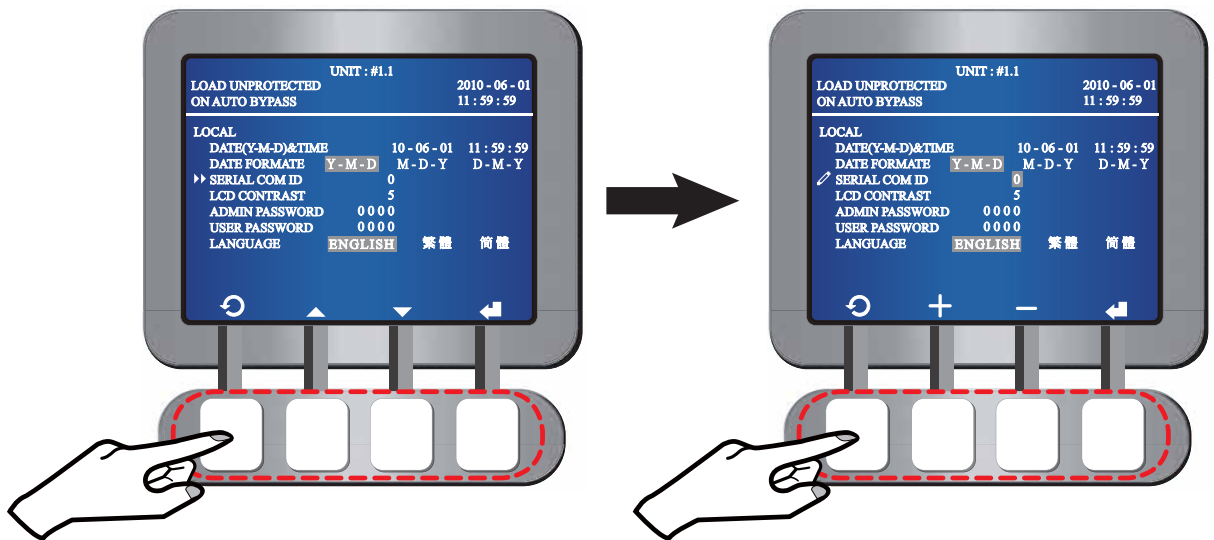

• LCD Contrast

1. In the **LOCAL** screen, use the function keys below the symbols ▲ and ▼ to select **LCD CONTRAST** and press the function key below the symbol ◀ to confirm your selection.
2. When the symbol ▶▶ changes to the symbol ✎, use the function keys below the symbols + and - to set up the LCD contrast, and press the function key below the symbol ◀ to confirm your setup.

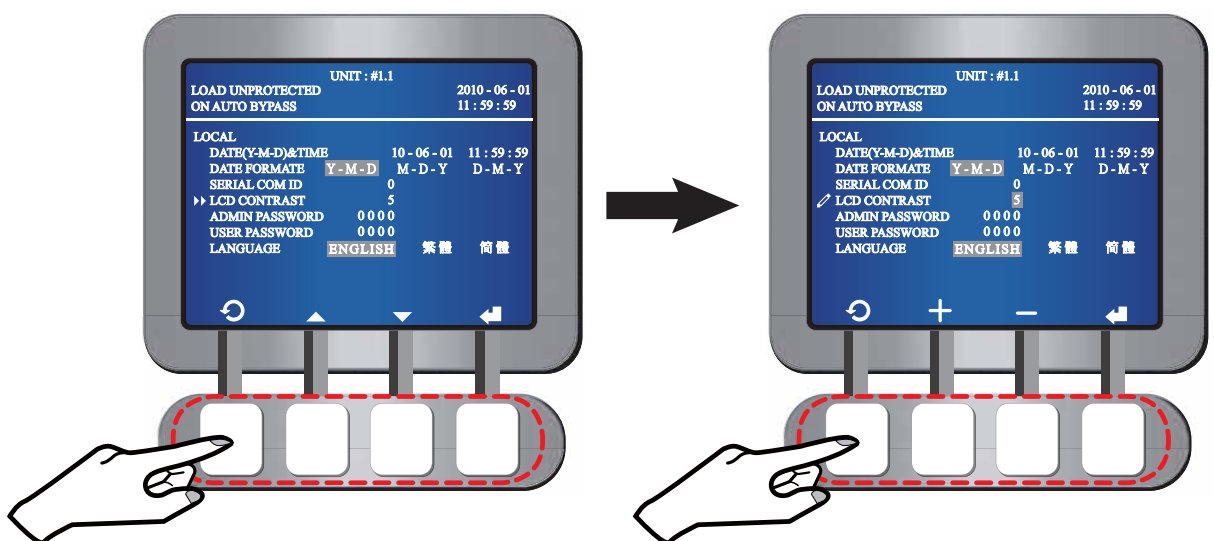

• Administrator Password

1. The administrator password includes four digits. In the **LOCAL** screen, use the function keys below the symbols ▲ and ▼ to select **ADMIN PASSWORD** and press the function key below the symbol ◀ to confirm your selection.
2. When the symbol ▶▶ changes to the symbol ✎, use the function keys below the symbols + and - to set up the administrator password, and press the function key below the symbol ◀ to confirm your setup.

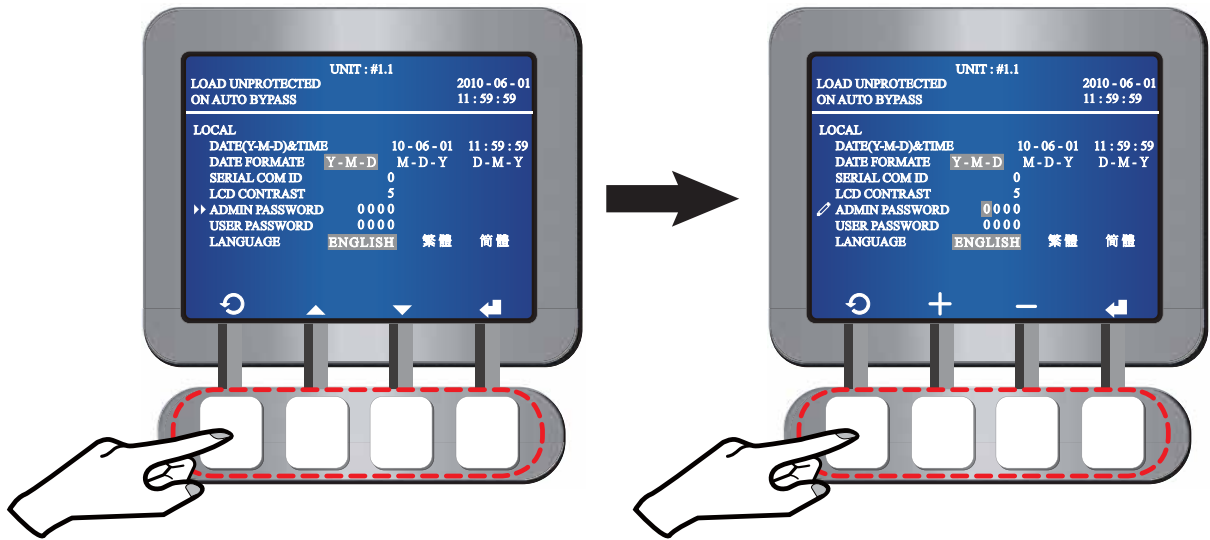

• User Password

1. The user password includes four digits. In the **LOCAL** screen, use the function keys below the symbols ▲ and ▼ to select **USER PASSWORD** and press the function key below the symbol ◀ to confirm your selection.
2. When the symbol ▶▶ changes to the symbol ✎, use the function keys below the symbols + and - to set up the user password, and press the function key below the symbol ◀ to confirm your setup.

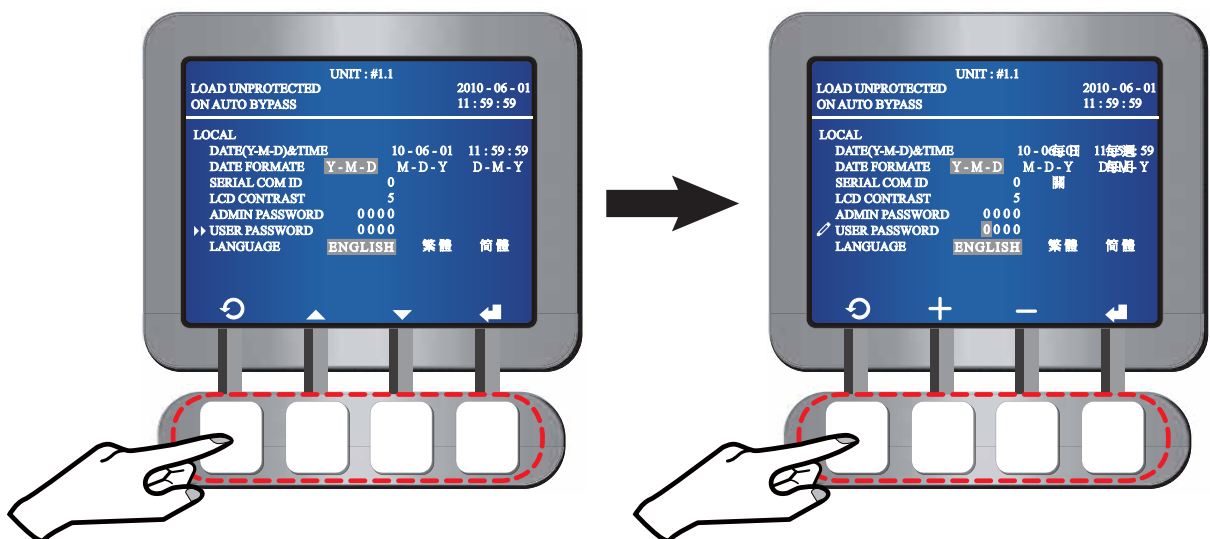

- **Language**

1. In the **LOCAL** screen, use the function keys below the symbols ▲ and ▼ to select **LANGUAGE** and use the function key below the symbol ◀ to confirm your selection.
2. When the symbol ▶▶ changes to the symbol ✎, use the function keys below the symbols ◀ and ▶ to select an LCD display language and press the function key below the symbol ◀ to confirm your selection.

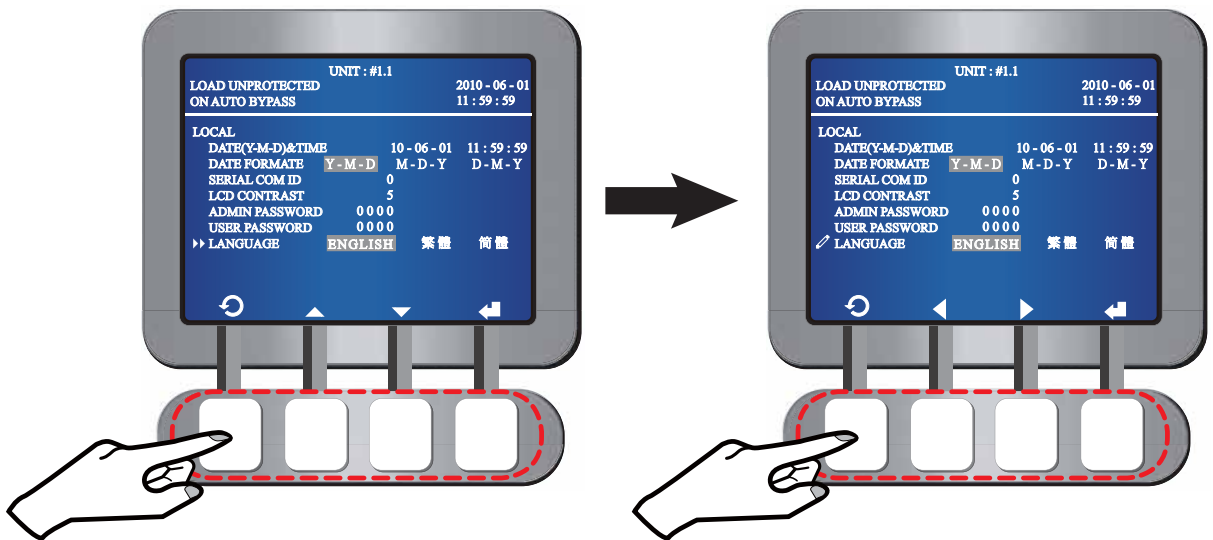

Press the function key below the symbol ↻ to go back to the **UPS SETUP & CONTROL** screen.

7.6 Maintenance

In the **Main Menu** shown in the bottom left figure, use the function keys below the symbols ▲ and ▼ to select **MAINTENANCE**, and press the function key below the symbol ◀ to enter into **MAINTENANCE** screen. In **MAINTENANCE** screen shown in the bottom right figure, it presents UPS serial No. (for example: E1E08200013W0).

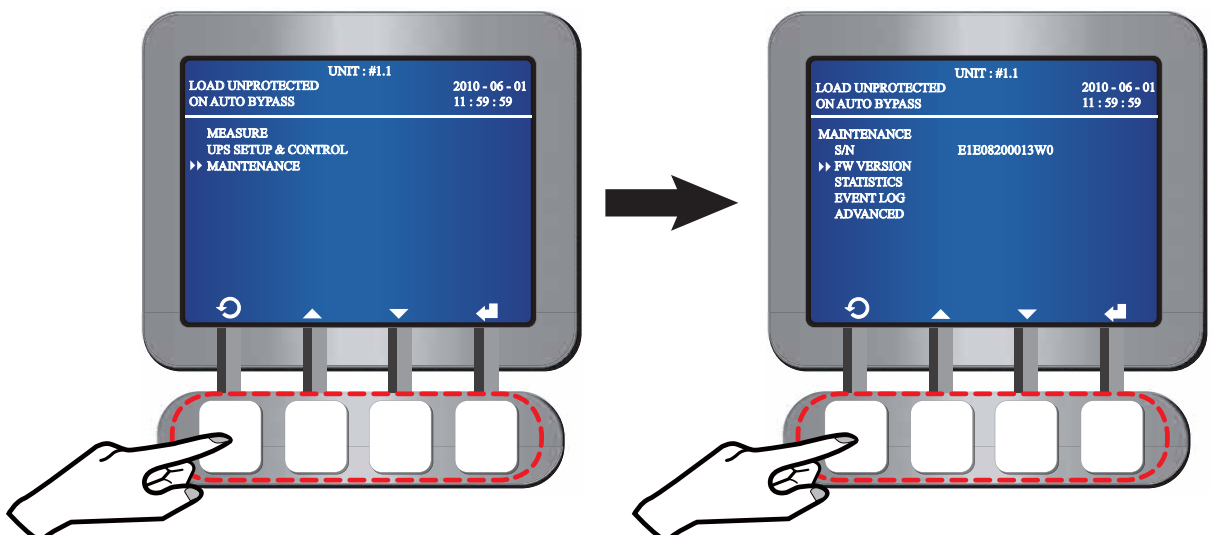

7.6.1 Firmware Version

In the **MAINTENANCE** screen, use the function keys below the symbols ▲ and ▼ to select **FW VERSION**. Press the function key below the symbol ◀ and you will see information about **SYSTEM, DISPLAY, and PWR UNIT**.

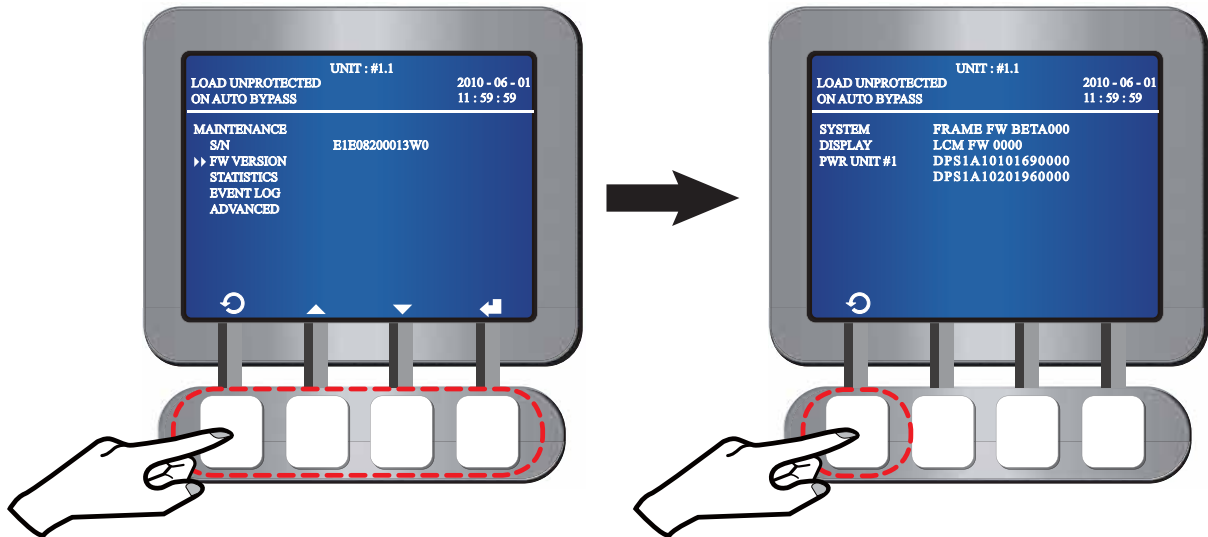

7.6.2 Statistics

In the **MAINTENANCE** screen, use the function keys below the symbols ▲ and ▼ to select **STATISTICS**. Press the function key below the symbol ◀ and you will see information about **ON BAT COUNTS, ON BYPASS COUNTS, and OPERATION TIME (Y-D-H-M)**.

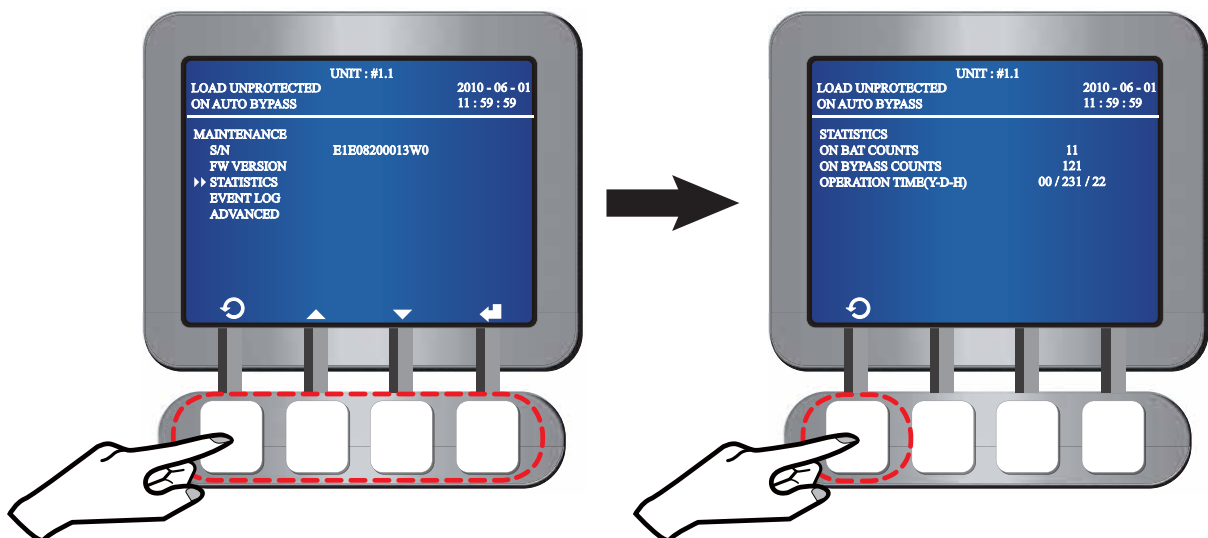

7.6.3 Event Log

In the **MAINTENANCE** screen, use the function keys below the symbols ▲ and ▼ to select **EVENT LOG**. Press the function key below the symbol ◀ and you will see information about event logs.

Use the function keys below the symbols ▲ and ▼ to switch between event logs.

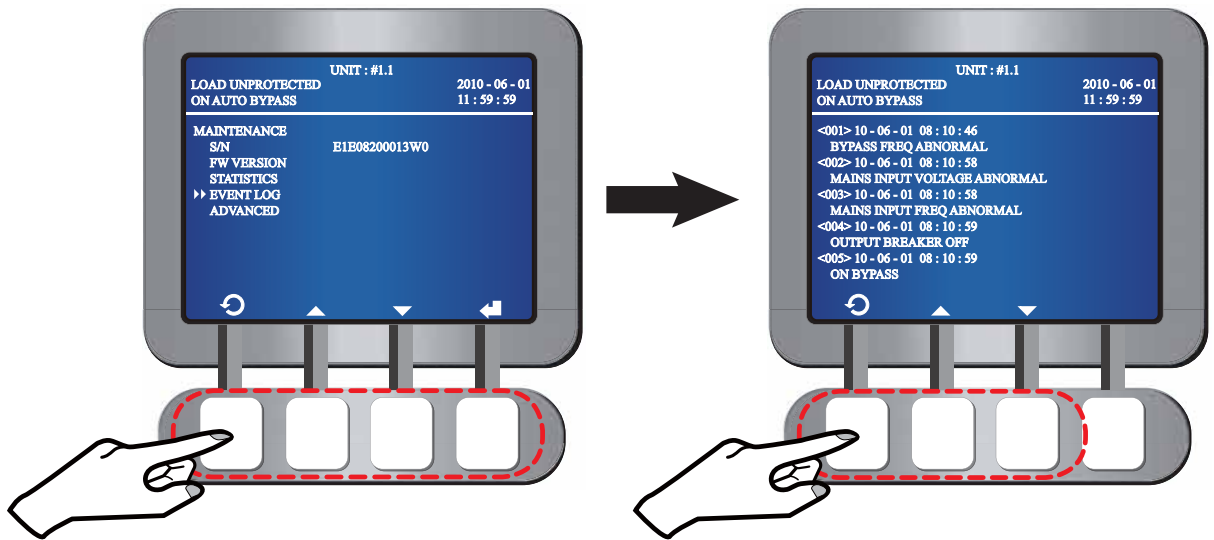

7.6.4 Advanced Setup



In **ADVANCED** screen, only the administrator can modify the advanced setup. Please refer to **7.5 UPS SETUP & CONTROL** for login information.

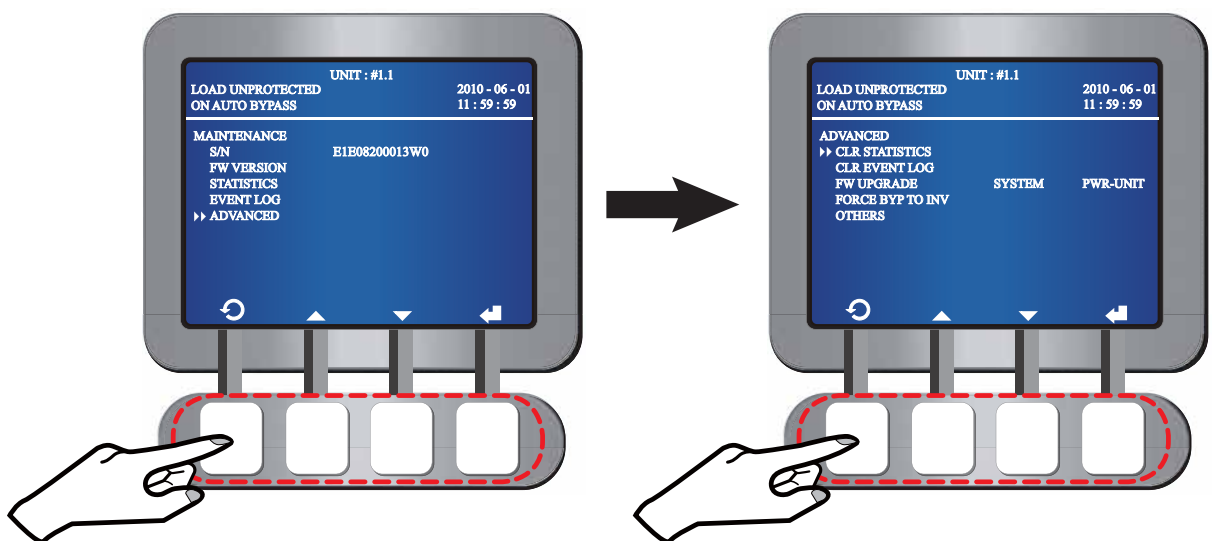

In the **MAINTENANCE** screen, use the function keys below the symbols ▲ and ▼ to select **ADVANCED**, and press the function key below the symbol ◀ to enter into **ADVANCED** screen.



- **To Clear Statistics**

1. In the **ADVANCED** screen, use the function keys below the symbols ▲ and ▼ to

select **CLR STATISTICS** and press the function key below the symbol  to confirm your selection.



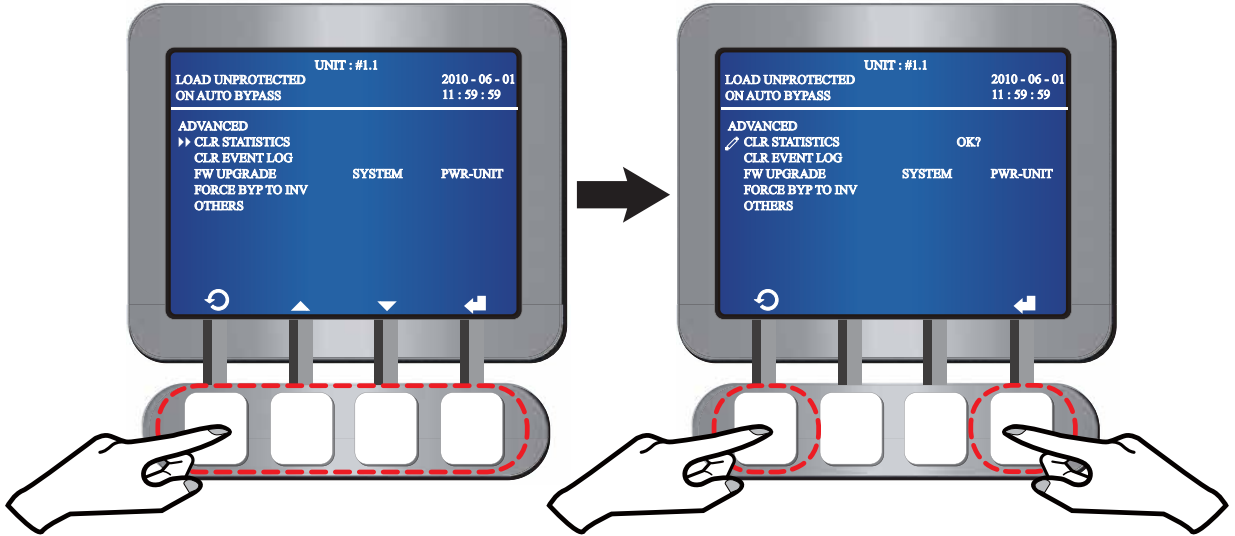



- When the symbol  changes to the symbol , press the function key below the symbol  to confirm your selection.



NOTE 

Once you press the function key below the symbol , all statistics are cleared.

• **To Clear Event Log**



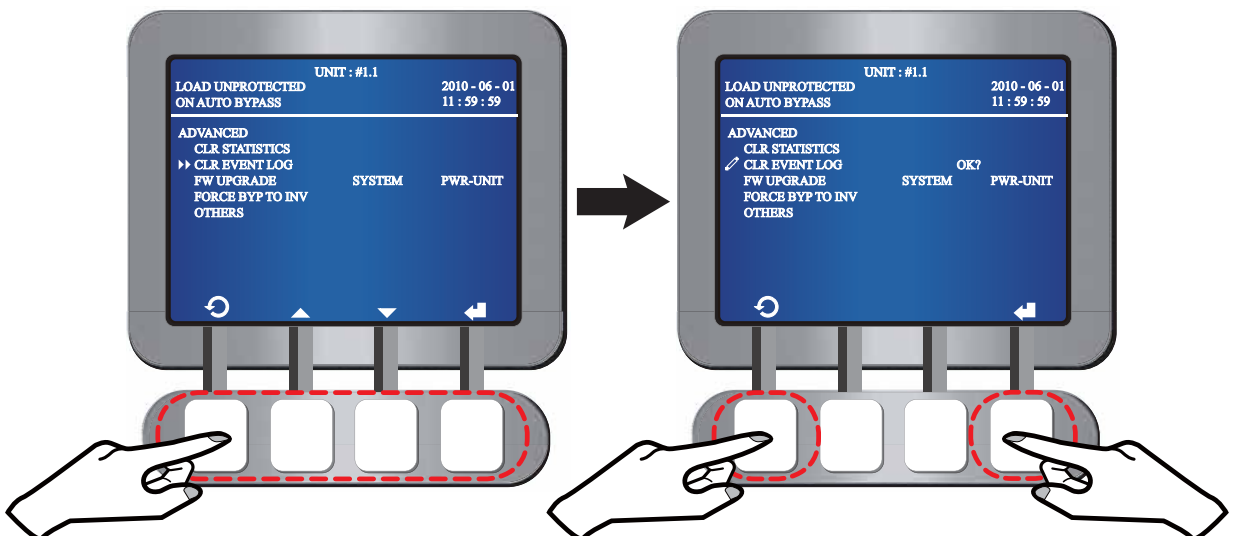





- In the **ADVANCED** screen, use the function keys below the symbols  and  to select **CLR EVENT LOG** and press the function key below the symbol  to confirm your selection.
- When the symbol  changes to the symbol , press the function key below the symbol  to confirm your selection.





Once you press the function key below the symbol , all event logs are cleared.

• Firmware Upgrade

1. In the **ADVANCED** screen, use the function keys below the symbols  and  to select **FW UPGRADE** and press the function key below the symbol  to confirm your selection.
2. When the symbol  changes to the symbol , use the function keys below the symbols  and  to select **SYSTEM** or **PWR-UNIT**. Press the function key below the symbol  to confirm your selection.

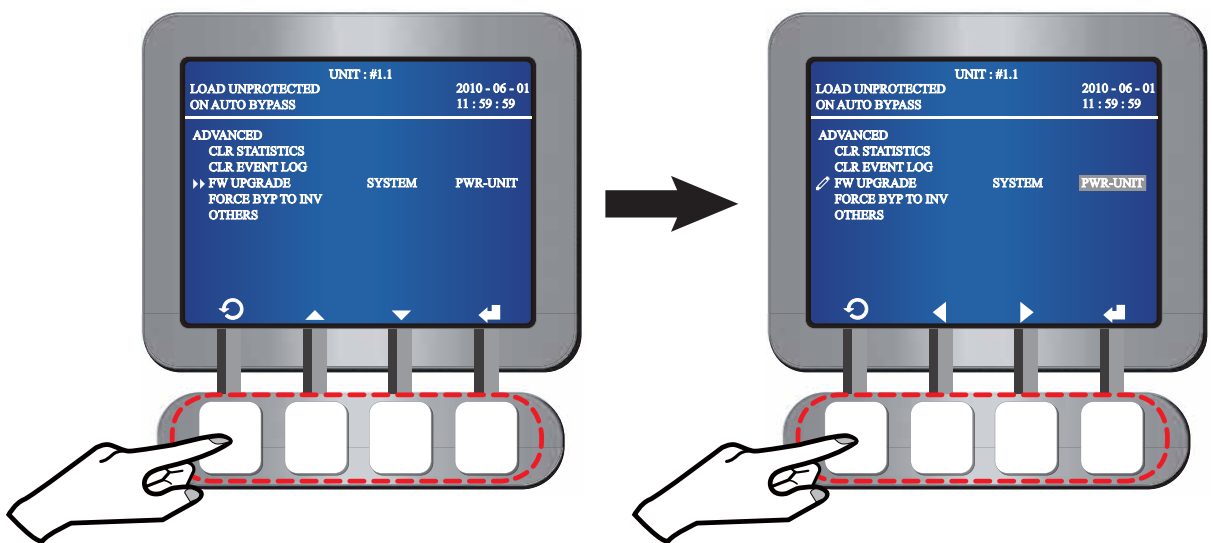

If you choose **PWR-UNIT**, the following screens will appear in order.

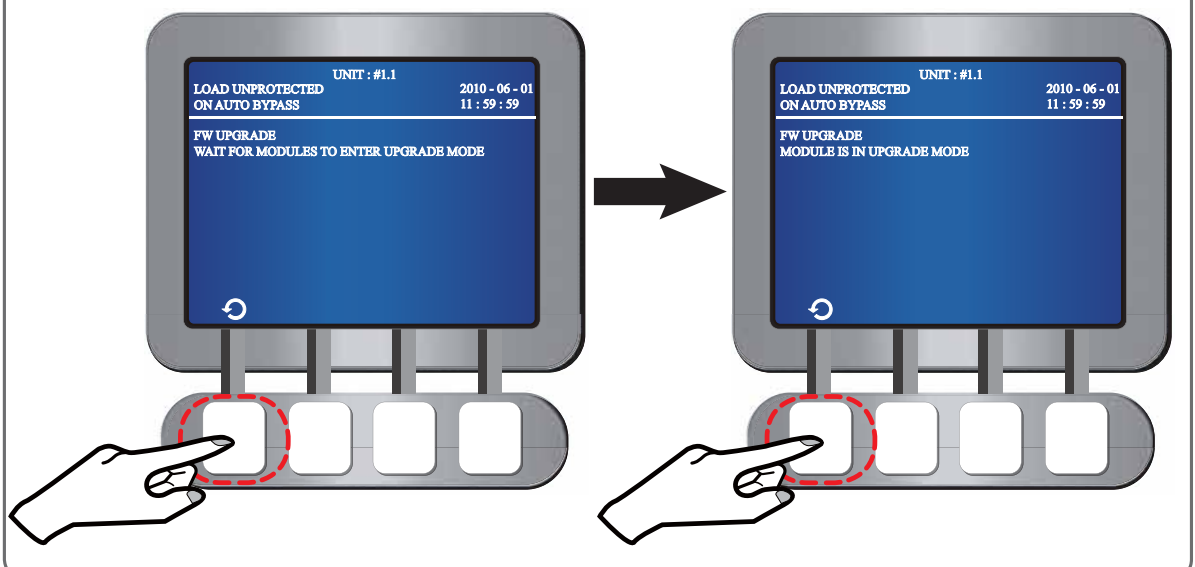

• **To Force to Transfer from Bypass Mode into Inverter Mode**

1. In the **ADVANCED** screen, use the function keys below the symbols ▲ and ▼ to select **FORCE BYP TO INV** and press the function key below the symbol ◀ to confirm your selection.
2. When the symbol ▶▶ changes to the symbol ✎, press the function key below the symbol ◀ to confirm your selection.

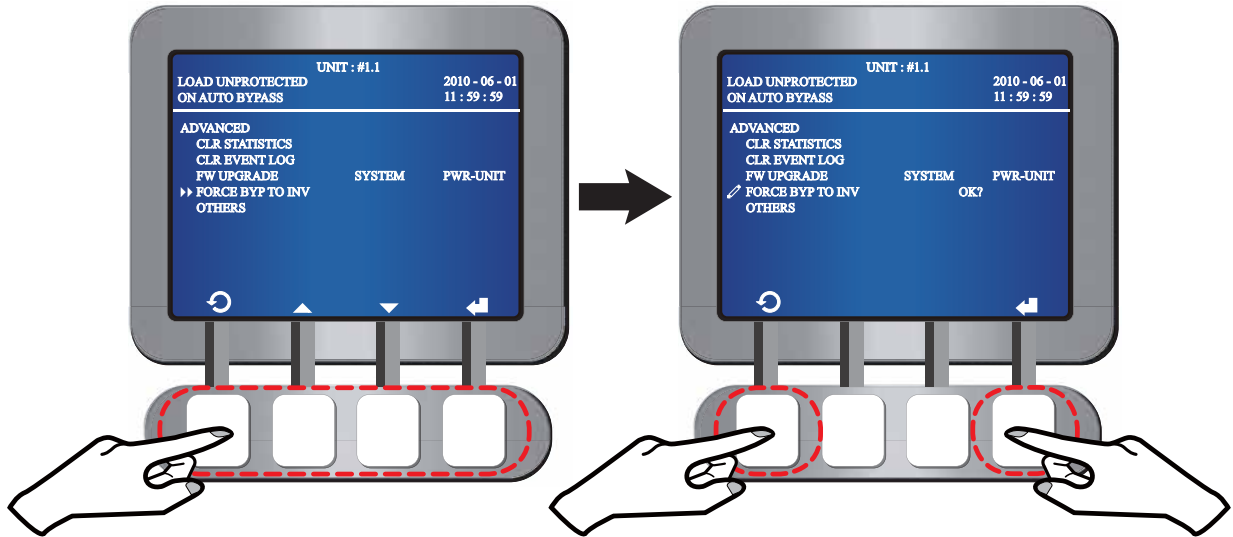

NOTE

Once you press the function key below the symbol ◀, the system will transfer from bypass mode to normal mode.

• **Others**

1. In the **ADVANCED** screen, use the function keys below the symbols ▲ and ▼ to select **OTHERS**, press the function key below the symbol ◀ to confirm your selection and you will see the following screens.
2. Use the function keys below the symbols ▲ and ▼ to switch between screens to obtain relevant information.

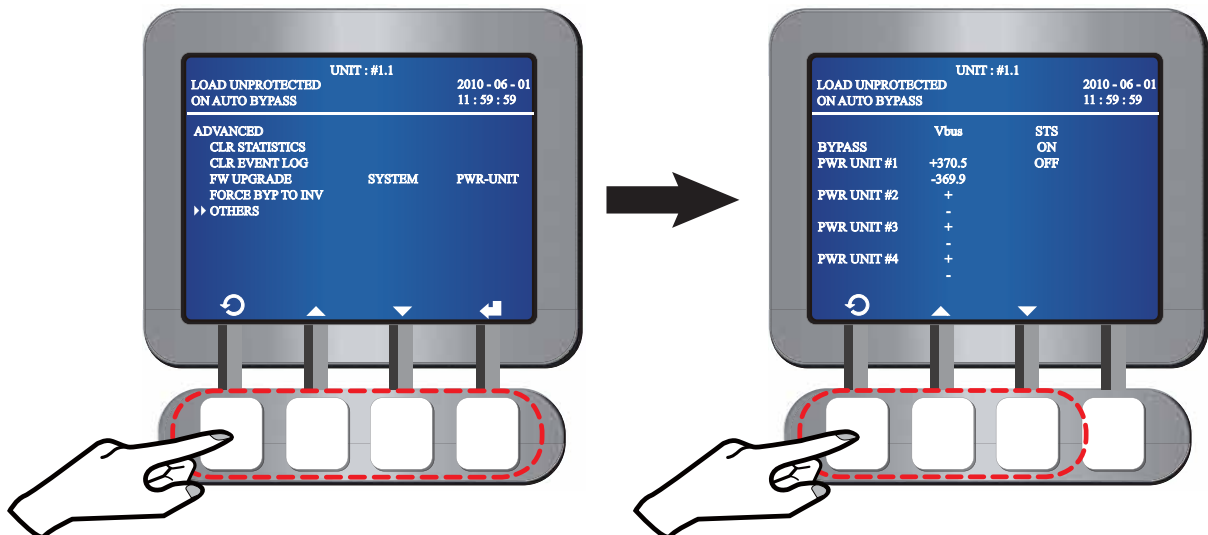

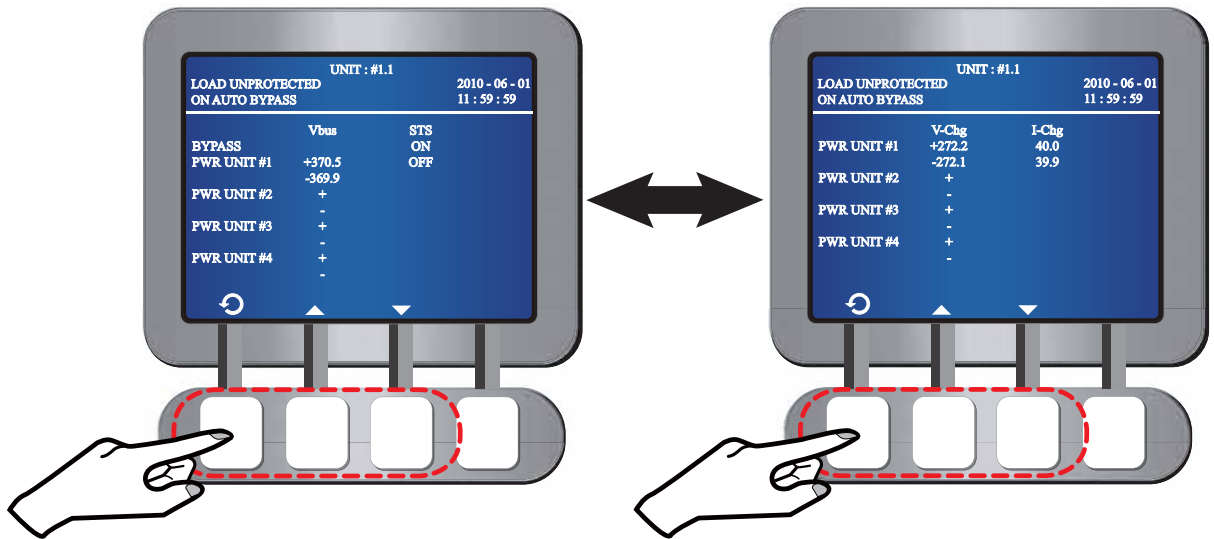

Press the function key below the symbol  to go back to the **MAINTENANCE** screen.

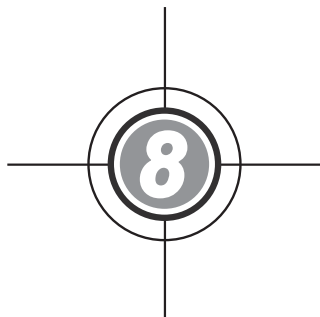

Optional Accessories

There are several optional accessories available for this DPS series UPS. Please refer to the table below for the optional accessories and their descriptions.

No.	Item	Function
1.	Dust Filter	Prevents dust from entering into the UPS to ensure UPS reliability and to prolong product life.
2.	SNMP Card	Monitors the status of the UPS via internet.
3.	Relay I/O Card	Increases the quantity of dry contacts.
4.	ModBus Card	Lets the UPS have ModBus communication function.
5.	External Battery Cabinet	Provides external batteries that let the UPS supply power to the equipment loads connected when a power failure occurs.
6.	Transformer	Provides step-up, step-down or Galvanic isolation function.
7.	Battery cabinet temperature sensor cable	Detects the temperature of a Delta external battery cabinet connected to the UPS.
8.	Battery cabinet status sensor cable	Detects the status of a Delta external battery cabinet connected to the UPS.

NOTE 

1. For detailed installation and operation of any accessory mentioned above, please refer to the **Quick Guide**, **User Guide**, or **Installation & Operation Guide** included in the package of the relevant optional accessory.
2. If you want to buy any accessory mentioned above, please contact your local dealer.



Maintenance

- **UPS**

1. UPS Cleaning:

Regularly clean the UPS, especially the slits and openings, to ensure that the air freely flows into the UPS to avoid overheating. If necessary, use an air-gun to clean the slits and openings to prevent any object from blocking or covering these areas.

2. UPS Regular Inspection:

Regularly check the UPS every half year and inspect:

- 1) Whether the UPS, LEDs, and alarm function are operating normally.
- 2) Whether the UPS works in bypass mode (normally, the UPS will work in normal mode). If yes, check if any error, overload, internal fault, etc. occurs.
- 3) Whether battery voltage is normal. If the battery voltage is too high or too low, find the root cause.

- **Battery**

The DPS series UPS uses sealed lead-acid batteries. The battery life depends on the temperature, the usage, and the charging/ discharging frequency. High temperature environments and high charging/ discharging frequency will quickly shorten the battery life. Please follow the suggestions below to ensure a normal battery lifetime.

1. Keep usage temperature between 15°C~25°C (59°F~77°F).
2. When the UPS needs to be stored for an extended period of time, the batteries must be recharged once every three months and the charging time must not be less than 24 hours each time.

- **Fan**

Higher temperatures shorten fan life. When the UPS is running, please check if all of the twelve fans on the top of the UPS and two fans used to cool the charger work normally and make sure if the ventilation air can move freely around and through the UPS. If not, replace the fans.



Please ask your local dealer or customer service for more maintenance information. Do not perform maintenance if you are not trained for it.

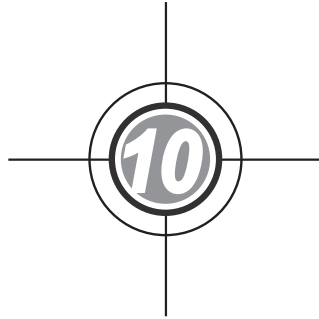

Troubleshooting

When you see the following alarm messages appear on the LCD, please follow the solutions shown below.

No.	Alarm Message	Possible Cause	Solution
1	MAINS INPUT VOLT OR FREQ NOK	<ol style="list-style-type: none"> 1. The Main Input Switch (Q1) is turned off. 2. The main AC source's voltage or frequency is abnormal. 	<ol style="list-style-type: none"> 1. Check whether the Main Input Switch (Q1) is turned off. If yes, turn it on. 2. If the Main Input Switch (Q1) is turned on but the alarm still exists, contact your local dealer. 3. Check if the main AC source's voltage or frequency is abnormal. If yes, please wait until the main AC source becomes normal.
2	MAINS INPUT PHASE SEQ NOK	Wrong wiring	Check if the main AC source's wiring and phase sequence are correct. If not, please contact your local dealer.
3	PWR UNIT #n PFC FUSE OPEN SHUT-DOWN	PFC fuse is fused.	Contact your local dealer.
4	PWR UNIT #n INV FUSE OPEN SHUT-DOWN	Inverter fuse is fused.	Contact your local dealer.
5	PWR UNIT #n GENERAL FAULT	Power unit's control circuit has abnormalities, e.g. abnormal auxiliary power, failing soft start, etc.	Contact your local dealer.
6	SYSTEM GENERAL FAULT	System's auxiliary power is abnormal.	Contact your local dealer.
7	BAT CABINET OVER HEAT	<ol style="list-style-type: none"> 1. Battery cabinet's temperature is too high. 2. Battery cabinet has abnormalities. 	<ol style="list-style-type: none"> 1. Decrease the battery cabinet's temperature. 2. Check if the battery cabinet has any abnormality. If yes, contact your local dealer.
8	BAT TEST FAIL	<ol style="list-style-type: none"> 1. Wrong battery wiring 2. Battery abnormality 	<ol style="list-style-type: none"> 1. Check if battery grounding is correct or not. If not, contact your local dealer. 2. Check if battery has abnormalities. If yes, contact your local dealer to replace battery.
9	BAT LOW WARNING	Battery voltage is lower than warning limit.	If there is no backup power, immediately shut down the equipment loads connected to the UPS.

No.	Alarm Message	Possible Cause	Solution
10	LOW BAT CUT OFF	Battery voltage is lower than shutdown limit.	If there is no backup power, the UPS will automatically discontinue power supply to the equipment loads to protect battery until battery power recovers.
11	BAT REPLACE REQUIRED	1. System date is wrongly set. 2. Battery replacement date is due.	1. Check if system date is set correctly. If not, correct it. 2. Check if battery replacement date is due. If yes, contact your local dealer to replace battery (ies).
12	PWR UNIT #n CHARGER FAIL	Charger temperature is too high.	Contact your local dealer
13	BAT OVER CHARGE	Charger is abnormal.	Contact your local dealer
14	BAT MISSING	1. Wrong battery wiring 2. Insufficient battery voltage	1. Check if battery wiring is correct or not. If not, contact your local dealer. 2. Check if battery voltage is abnormal or not. If yes, contact your local dealer.
15	PWR UNIT #n PFC OVER HEAT WARNING	1. Fans have abnormalities. 2. Foreign matter is stuck in the fans.	Check if fans work abnormally or foreign matter is blocking a fan. If yes, contact your local dealer. If not, please decrease some equipment loads.
16	PWR UNIT #n PFC OVER HEAT SHUTDOWN	1. Fans have abnormalities. 2. Foreign matter is stuck in the fans.	Check if fans work abnormally or foreign matter is blocking a fan. If yes, contact your local dealer. If not, please decrease some equipment loads.
17	PWR UNIT #n INV OVER HEAT WARNING	1. Fans have abnormalities. 2. Foreign matter is stuck in the fans.	Check if fans work abnormally or foreign matter is blocking a fan. If yes, contact your local dealer. If not, please decrease some equipment loads.
18	PWR UNIT #n INV OVER HEAT SHUTDOWN	1. Fans have abnormalities. 2. Foreign matter is stuck in the fans.	Check if fans work abnormally or foreign matter is blocking a fan. If yes, contact your local dealer. If not, please decrease some equipment loads.
19	PFC SCR FAULT SHUTDOWN	1. PFC SCR is damaged. 2. Driving circuit is damaged.	Contact your local dealer

No.	Alarm Message	Possible Cause	Solution
20	PWR UNIT #n DC BUS NOK	DC BUS voltage is too high or too low.	Contact your local dealer
21	PWR UNIT #n INV OUTPUT NOK	Inverter's output voltage is too high or too low.	Contact your local dealer
22	UPS OUTPUT FAULT SHUTDOWN	Inverter's output voltage is too high or too low.	Contact your local dealer
23	INV OVER CURRENT	Output might have shorting issues.	Contact your local dealer
24	PWR UNIT #n INV SHORT CIRCUIT	Output might have shorting issues.	Contact your local dealer
25	PWR UNIT #n INV STS FAIL SHUTDOWN	1. Inverter's static switch is damaged. 2. Inverter's driving circuit is damaged.	Contact your local dealer
26	BYPASS STS OVER HEAT	1. Fans have abnormalities. 2. Foreign matter is stuck in the fans. 3. UPS is overloaded.	Check if fans work abnormally or foreign matter is blocking a fan. If yes, contact your local dealer. If not, please decrease equipment loads.
27	BYPASS INPUT VOLT OR FREQ NOK	1. The Bypass Switch (Q2) is turned off. 2. Bypass voltage or frequency is abnormal.	1. Check if the Bypass Switch (Q2) is turned off. If yes, turn it on. 2. If the Bypass Switch (Q2) is turned on but the alarm still exists, contact your local dealer. 3. Check if bypass voltage or frequency is abnormal. If yes, please wait until bypass AC source becomes normal.
28	BYPASS INPUT PHASE SEQ NOK	Wrong wiring	Check if the bypass AC source's wiring and phase sequence are correct. If not, contact your local dealer.
29	BYPASS STS OVER CURRENT	The UPS is overloaded.	Decrease some equipment loads.
30	BYPASS STS FAIL	1. Bypass static switch is damaged. 2. Bypass driving circuit is damaged.	Contact your local dealer
31	EMERGENCY POWER OFF	Emergent shutdown is executed.	Shut down the UPS. After emergency events are eliminated, follow turn-on procedures to start up the UPS.

No.	Alarm Message	Possible Cause	Solution
32	PWR UNIT #n COMMUNICATION NOK	<ol style="list-style-type: none"> 1. Internal communication cable is not firmly connected. 2. Communication circuit is abnormal. 	Contact your local dealer
33	EXT PARALLEL COMMUNICATION NOK	Parallel cable is not firmly connected.	Check if parallel cable is firmly connected or not. If not connect it firmly.
34	PARALLEL FAIL	<ol style="list-style-type: none"> 1. Parallel UPSs are not compatible. 2. There are conflicts between parallel UPSs' IDs. 	<ol style="list-style-type: none"> 1. Check if there are conflicts between parallel UPSs' IDs. If yes, contact your local dealer. 2. Check if parallel UPSs are compatible or not. If not, contact your local dealer.
35	ON MANUAL BYPASS	The Manual Bypass Switch (Q3) is turned on.	<ol style="list-style-type: none"> 1. Check if the Manual Bypass Switch (Q3) is turned on. If yes, turn it off. 2. If the Manual Bypass Switch (Q3) is turned off and the alarm still exists, contact your local dealer.
36	REDUNDANCY LOSS	Overload causes redundancy failure.	Decrease equipment loads and reset redundancy.
37	INPUT TRANSFORMER OVER HEAT	<ol style="list-style-type: none"> 1. Fans have abnormalities. 2. Foreign matter is stuck in the fans. 3. UPS is overloaded. 	Check if fans work abnormally or foreign matter is blocking a fan. If yes, contact your local dealer. If not, decrease equipment loads.
38	OUTPUT TRANSFORMER OVER HEAT	<ol style="list-style-type: none"> 1. Fans have abnormalities. 2. Foreign matter is stuck in the fans. 3. UPS is overloaded. 	Check if fans work abnormally or foreign matter is blocking a fan. If yes, contact your local dealer. If not, please decrease equipment loads.
39	LCM COMMUNICATION LOSS	<ol style="list-style-type: none"> 1. LCM communication cable is not firmly connected. 2. LCM communication circuit is abnormal. 	<ol style="list-style-type: none"> 1. Check if the LCM communication cable is firmly connected. If not, connect it firmly. 2. If the LCM communication cable is firmly connected but the alarm still exists, the LCM communication circuit might have abnormalities. Please contact your local dealer.
40	PWR UNIT #n NOT CALIBRATED	EEPROM is damaged.	Contact your local dealer
41	SYSTEM COMMUNICATION NOK	System's communication circuit is abnormal.	Contact your local dealer

No.	Alarm Message	Possible Cause	Solution
42	PWR UNIT #n PFC PLL NOT SYNC	Control circuit is abnormal.	Contact your local dealer
43	OUTPUT OVERLOAD WARNING	The UPS is overloaded.	Decrease equipment loads.
44	OUTPUT OVERLOAD SHUTDOWN	The UPS is overloaded.	Decrease equipment loads.
45	PWR UNIT #n AB-NORMAL CHANGE	Power unit's control circuit is abnormal.	Contact your local dealer
46	OUTPUT BREAKER OFF	The UPS Output Switch (Q4) is turned off.	<ol style="list-style-type: none"> 1. Check if the UPS Output Switch (Q4) is turned off. If yes, turn it on. 2. If the UPS Output Switch (Q4) is turned on but the alarm still exists, contact your local dealer.
47	BATTERY BREAKER OFF	Battery circuit breaker is turned off.	<ol style="list-style-type: none"> 1. Check if the battery circuit breaker is turned off. If yes, turn it on. 2. If the battery circuit breaker is turned on but the alarm still exists, contact your local dealer.
48	EXT PARALLEL UN-COMPATIBLE	The firmware versions between parallel UPSs are not compatible.	Contact your local dealer
49	FRAME OVER AUTO RECOVER LIMIT	System's repeated auto protection frequency is over limit.	Contact your local dealer
50	PWR UNIT #n OVER AUTO RECOVER LIMIT	Power unit's repeated auto protection frequency is over limit.	Contact your local dealer
51	OUT OF ECO RANGE	Bypass voltage or frequency is out of ECO mode limit.	Check the bypass voltage and frequency. If abnormal, contact your local dealer.

NOTE 

If all possible causes are eliminated but the alarm still appears, please contact your local dealer or customer service.

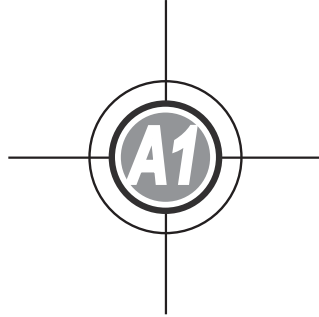

Technical Specifications

Model		DPS160	DPS200
Power Rating		160 kVA/144 kW	200 kVA/180 kW
Input	Nominal Voltage	380/220, 400/230, 415/240 Vac (3 phase, 4-wire + G)	
	Voltage Range	242 ~ 477/140 ~ 276 Vac * ¹	
	Current Harmonic Distortion	≤ 3%	
	Power Factor	> 0.99	
	Frequency	50/60 Hz	
Output	Voltage	380/220, 400/230, 415/240 Vac (3 phase, 4-wire + G)	
	Voltage Harmonic Distortion	≤ 1.5% (linear load)	
	Voltage Regulation	± 1% (static)	
	Power Factor	0.9	
	Frequency	50/60 Hz	
	Frequency Regulation	± 0.05 Hz (battery mode)	
	Overload Capability	≤ 125%: 10 minutes; ≤ 150%: 1 minute	
Display	LED indicators; Mimic LCD (multi-language supported)		
Interface	Standard	RS232 x 1, SNMP slot x 2, Input dry contact x 2, Output dry contact x 6	
	Optional	SNMP card, Modbus card, Relay I/O card, Battery cabinet temperature sensor cable, Battery cabinet status sensor cable	
Efficiency	Online Mode	95%	
	ECO Mode	99%	
Battery	Nominal Voltage	± 240 Vdc	
	Charge Voltage	± 272V (adjustable from 254V to 291V)	
	Protection of Battery Deep Discharge	Yes	
Environment	Operating Temperature	0 ~ 40°C	
	Relative Humidity	95% (non-condensing)	
	Audible Noise	< 70 dBA (at one meter)	
	IP Degree of Protection	IP20	
Others	Parallel Redundancy & Expansion	Yes (up to 8 units)	
	Emergency Power Off	Yes (local and remote)	
	Battery-start	Yes	
	Transformer	Yes (optional)	
Physical	Dimensions (WxDxH)	UPS	850 x 865 x 1950 mm
		UPS with Transformer	1400 x 865 x 1950 mm
	Weight	UPS	721 kg
		UPS with Transformer	1485 kg

NOTE 

1. Refer to the rating label for the safety rating.
2. All specifications are subject to change without prior notice.

*1: When input voltage is 140/242~187/324 Vac, the sustainable loading is from 70% to 100% of the UPS capacity.



Seller warrants this product, if used in accordance with all applicable instructions, to be free from original defects in material and workmanship within the warranty period. If the product has any failure problem within the warranty period, Seller will repair or replace the product at its sole discretion according to the failure situation.

This warranty does not apply to normal wear or to damage resulting from improper installation, operation, usage, maintenance or irresistible force (i.e. war, fire, natural disaster, etc.), and this warranty also expressly excludes all incidental and consequential damages.

Maintenance service for a fee is provided for any damage out of the warranty period. If any maintenance is required, please directly contact the supplier or Seller.



WARNING: The individual user should take care to determine prior to use whether the environment and the load characteristic are suitable, adequate or safe for the installation and the usage of this product. The User Manual must be carefully followed. Seller makes no representation or warranty as to the suitability or fitness of this product for any specific application.

Ultr^on DPS Series